

ООО «АЛЪЯНС» (499) 714-28-28  
WWW.ИНСТРУМЕНТЫ-ВСЕМ.РФ  
(499) 714-28-28 s7142828@yandex.ru



# SARIN

2014

01\_07\_2014



CATALOGUE - CATALOGO - CATALOGUE - KATALOG - КАТАЛОГ

SARIV

**SARIV<sup>®</sup>**

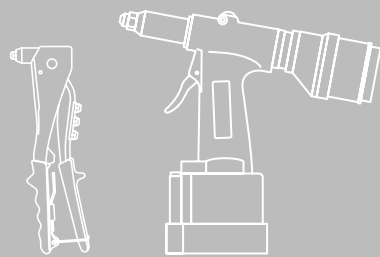
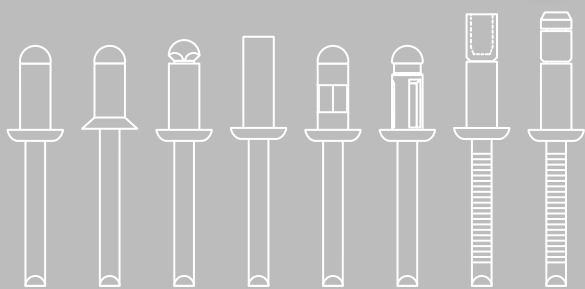



- On the market since 1990.
- Daily production of over 3 million pieces, in a production site of over 22.500 square meters, 6.000 covered.
- Internal laboratory for mechanical tests and sorting process with camera device.
- SARIV offers its customer the product engineering and the manufacturing of the product, to provide the ideal solution for every application.
- The design of the equipment for the production and process engineering are carried out by its own technical department.
- Logistics area based on a fully automated warehouse with a capacity of 5.000 load units.
- 5 SARIV-owned distribution companies in the Eastern Country and a production company (SARIV AUTOMOTIVE) for turning parts and plain rivets.



- Sul mercato dal 1990.
- Produzione giornaliera di oltre 3 milioni di pezzi, su un'area di 22.500 Mq, di cui 6.000 coperti.
- Laboratorio prove meccaniche e processo di selezione tramite telecamere interno all'azienda.
- SARIV offre ai propri cliente servizi di ingegnerizzazione di prodotto, per fornire la soluzione ideale per ogni applicazione.
- La progettazione dell'attrezzatura per la produzione e l'ingegnerizzazione del processo vengono svolti internamente dal dipartimento tecnico SARIV.
- Logistica con magazzino completamente automatico da 5.000 posti pallet.
- 5 Filiali distributive estere e una filiale produttiva (SARIV AUTOMOTIVE) per prodotti torniti speciali e ribattini.



- Dans le marché depuis 1990.
- Production journalière de plus de 3 millions de pièces, sur une surface de 22.500 m<sup>2</sup>, dont 6.000 m<sup>2</sup> couverts.
- Laboratoire interne pour tests mécaniques et procédure de sélection par cameras.
- SARIV propose son ingénierie de produits de service à la clientèle, afin de fournir la solution idéale pour chaque application.
- La conception de l'équipement pour la production et l'ingénierie des procédés sont effectués par son propre bureau technique.
- Zone logistique avec un magasin entièrement automatisé de 5.000 unités de charge.
- 5 filiales de distribution étrangères et une filiale productive (SARIV AUTOMOTIVE) pour produits tournés spéciaux.

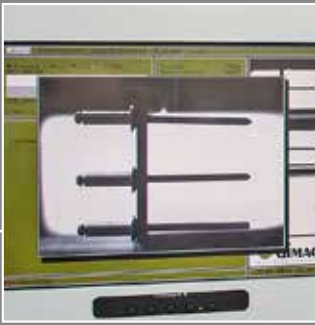

- Wir, die Firma Sariv, sind seit 1990 auf dem Markt.
- Unser Produktionsstandort umfasst 22.500 Quadratmeter, davon stehen 6.000 Quadratmeter für die Produktionshallen zur Verfügung. Mit unserem Maschinenpark können wir über 3.000.000 Teile / Tag herstellen.
- Im eigenen Labor machen wir die mechanischen Untersuchungen und die Opto - Elektronischen Sortierung.
- Sariv produziert nach Kundenwunsch und aufgrund spezieller Anwendungsbereiche der Kunden gezielt zugeschnittene Blindniete oder Blindnietmuttern.
- In der internen Konstruktionsabteilung entwickelt und fertigt Sariv seine Herstellungsmaschinen für die Blindniete.
- Unsere Logistik basiert auf einem völlig automatisierten Lager mit 5.000 Palettenplätzen.
- Wir haben 5 eigenen Vertriebsfirmen im Osten und eine Produktionsfirma (SARIV AUTOMOTIVE) für spezielle Drehteile.



- На рынке с 1990 года
- Ежедневно производятся более 3 миллионов единиц, на площади 22500 кв.м., из которых 6000 кв.м. крытого помещения.
- Лаборатория испытаний и отбор продукции на станках с внутренними телекамерами.
- SARIV предлагает своим клиентам услуги по разработке крепежных изделий, что позволяет обеспечить идеальное решение для разнообразного применения.
- Проектирование продукции для производства и инженерная разработка процесса выполняются в собственном отделе технического развития.
- Логистика с полностью автоматизированным складом на 5000 паллетов.
- 5 Зарубежных дистрибьюторных филиалов и один производственный филиал для выточенных изделий.

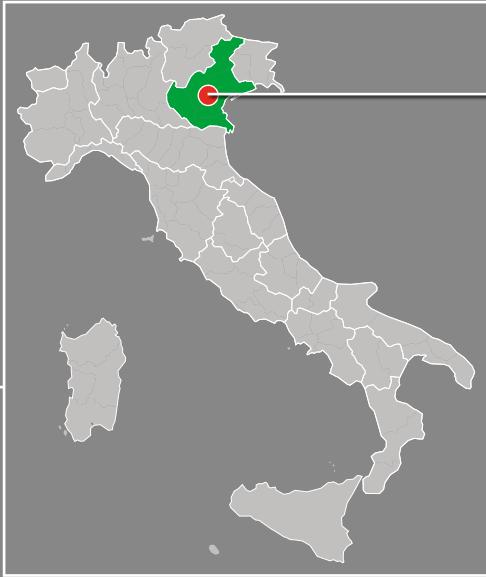

**PRODUCTION SITE  
& CENTRAL WAREHOUSE**

**OTHER SARIV COMPANIES**

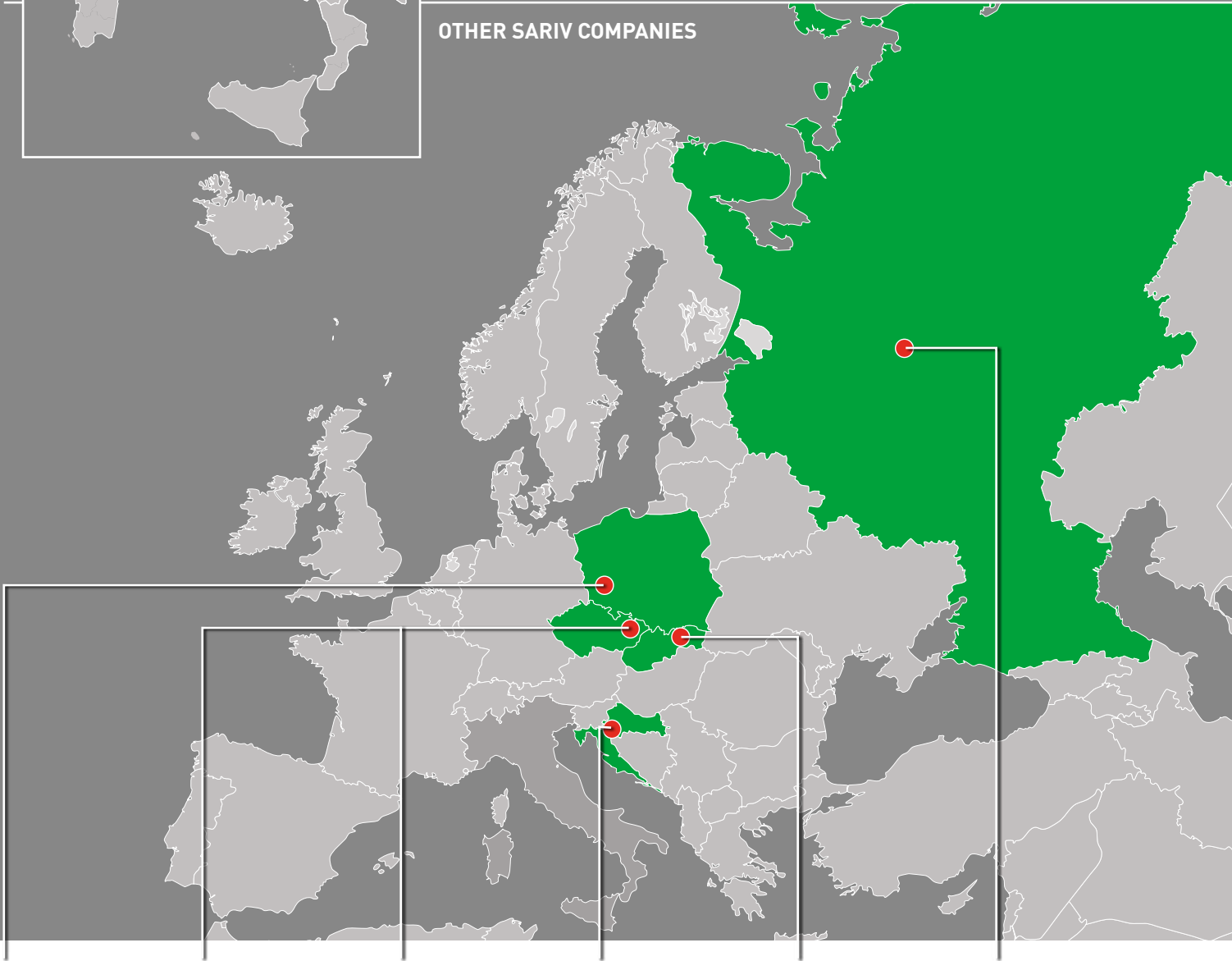

**SARIV Sp. z o. o.**  
POLAND



**SARIV-NEMCIK S.R.O.**  
CZECH REPUBLIC



**SARIV-AUTOMOTIVE S.R.O.**  
PRODUCTION SITE FOR  
TURNING PARTS AND PLAIN RIVETS



**SARIV D.O.O.**  
CROATIA



**SARIV S.R.O.**  
SLOVAKIA



**SARIV RUS O.O.O.**  
RUSSIA

**SARIV** in the web



**SARIV SRL**  
Production Plant



[www.sariv.it](http://www.sariv.it)

**STANDARD RIVETS  
 RIVETTI STANDARD  
 ВЫТЯЖНЫЕ КОМБИНИРОВАННЫЕ ЗАКЛЕПКИ**

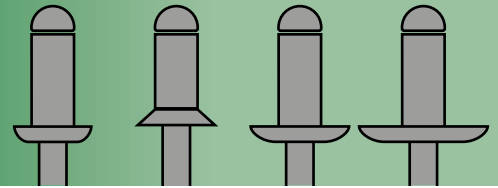

**SPECIAL RIVETS  
 RIVETTI SPECIALI  
 СПЕЦИАЛЬНЫЕ ВЫТЯЖНЫЕ ЗАКЛЕПКИ**

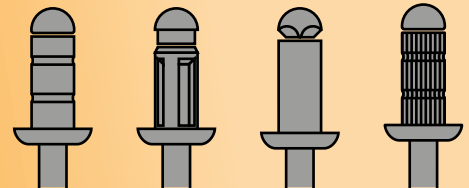

**STRUCTURAL RIVETS  
 RIVETTI STRUTTURALI  
 СТРУКТУРНЫЕ ВЫТЯЖНЫЕ ЗАКЛЕПКИ**

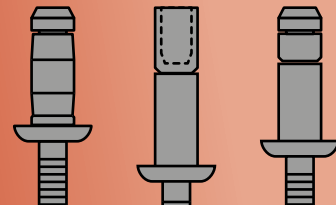

**BLIND RIVETS NUTS  
 INSERTI  
 ВЫТЯЖНЫЕ ГАЕЧНЫЕ ЗАКЛЕПКИ**

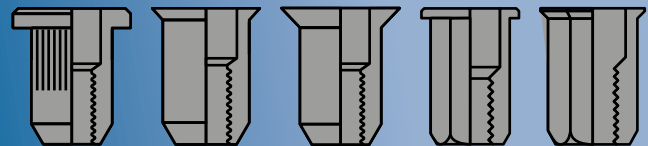

**RIVETING TOOL  
 RIVETTATRICI  
 ЗАКЛЕПОЧНИКИ**

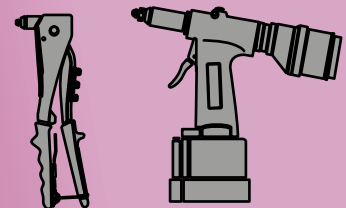

**STEEL ZINC PLATED CAGE NUTS  
 DADI IN GABBIA IN ACCIAIO ZINCATO  
 ГАЙКИ КЛЕТЕВЫЕ СТАЛЬНЫЕ (КУЗОВНЫЕ, ЗАКЛАДНЫЕ)**



**STEEL SPRING PINS  
 SPINE ELASTICHE IN ACCIAIO  
 ШТИФТЫ РАЗРЕЗНЫЕ ПРУЖИННЫЕ**



MATERIALS - MATERIALI - MATIÈRES - MATERIALIEN - МАТЕРИАЛЫ

<p><b>ALU</b> ALUMINIUM ALLUMINIO ALUMINIUM ALUMINIUM АЛЮМИНИЙ</p>	<p><b>ACC</b> ZINC PLATED STEEL ACCIAIO ZINCATO ACIER ZINGUE VERZINKTER STAHL ОЦИНКОВАННАЯ СТАЛЬ</p>	<p><b>INOX A2</b> INOX A2 INOX A2 INOX A2 EDELSTAHL A2 НЕРЖ.СТАЛЬ A2</p>	<p><b>CU</b> COPPER (Cu) RAME (Cu) CUIVRE (Cu) KUPFER (Cu) МЕДЬ (Cu)</p>	<p><b>CU.NI.</b> COPPER-NI. Cu 80% Ni 20% CU.NICKEL Cu 80% Ni 20% CU.NICKEL Cu 80% Ni 20% KUPFER-NI. Cu 80% Ni 20% МЕДНОНИКЕЛЕВЫЙ СПЛАВ Cu 80% Ni 20%</p>	<p><b>INOX A4</b> INOX A4 INOX A4 INOX A4 EDELSTAHL A4 НЕРЖ.СТАЛЬ A4</p>	<p><b>INOX</b> INOX INOX INOX EDELSTAHL НЕРЖ.СТАЛЬ</p>
--	--	--	--	---	--	--

HEAD TYPE - TIPO DI TESTA - TYPE DE TÊTE - ART DER KOPF - ТИП БОРТИКА

<p><b>TT</b> DOME HEAD TESTA TONDA TÊTE PLATE FLÄCHRUNDKOPF СТАНДАРТНЫЙ БОРТИК</p>	<p><b>TS</b> COUNTERSUNK HEAD TESTA SVASATA TÊTE FRAISÉE SENKKOPF ПОТайНОЙ БОРТИК (120°)</p>	<p><b>TL</b> LARGE HEAD TESTA LARGA TÊTE LARGE GROSSKOPF УВЕЛИЧЕННЫЙ БОРТИК</p>	<p><b>TXL</b> EXTRA-LARGE HEAD TESTA EXTRA-LARGA TÊTE EXTRA-LARGE EXTRA-GROSSKOPF ЭКСТРА УВЕЛИЧЕННЫЙ БОРТИК</p>

SPECIAL

<p><b>M'GRIP</b> MULTIGRIP TYPE RIVETTI MULTIGRIP RIVET MULTI-SERRAGE MEHRBEREICH МНОГОЗАЖИМНАЯ</p>	<p><b>FIORE</b> PEEL TYPE RIVETTO A FIORE RIVET ÉCLATÉ SPREIZNIET ЛЕПЕСТКОВАЯ</p>	<p><b>ERM</b> SEALED TYPE RIVETTO ERMETICO RIVET ÉTANCHE GESCHLOSSEN ЗАКРЫТАЯ</p>	<p><b>RAL</b> PAINTED BLIND RIVETS RIVETTI VERNICIATI RIVETS LAQUÉS GEFÄRBT BLINDNIETE ОКРАШЕННЫЕ ВЫТЯЖНЫЕ ЗАКЛЕПКИ</p>	<p><b>3 ALI</b> 3 WINGS 3 ALI 3 AILES 3 FLÜGEL РАСПОРНАЯ</p>	<p><b>SELF-SERVICE</b> SELF SERVICE PACK CONFEZIONI SELF SERVICE CONFECTIONS SELF SERVICE SELF-SERVICE PACKUNGEN МИНИ УПАКОВКА (БЛИСТЕР)</p>	<p><b>EL</b> ELECTRICAL APPLICATIONS APPLICAZIONE ELETTRICHE APPLICATIONS ÉLECTRIQUES ELEKTRISCHE ANWENDUNG ПРИМЕНЕНИЕ В ЭЛЕКТРИКЕ</p>

STRUTTURALI

<p><b>SARIBULB</b> HIGH RESISTANCE ALTA RESISTENZA HAUTE RESISTANCE HOHE FESTIGKEIT ВЫСОКОПРОЧНАЯ</p>	<p><b>SARIBOLT</b> HIGH RESISTANCE ALTA RESISTENZA HAUTE RESISTANCE HOHE FESTIGKEIT ВЫСОКОПРОЧНАЯ</p>	<p><b>ULTRABOLT</b> HIGH RESISTANCE ALTA RESISTENZA HAUTE RESISTANCE HOHE FESTIGKEIT ВЫСОКОПРОЧНАЯ</p>

MATERIAL	MATERIAL	HEAD TYPE - TIPO DI TESTA - TYPE DE TÊTE - ART DER KOPF - ТИП БОРТИКА				pag.
<b>STANDARD RIVETS</b>						
ALU	ACC	TT				10 - 12
			TS			13
				TL		14
					TXL	15
ALU	INOX A2	TT				16
ALU	ALU	TT				17
ACC	ACC	TT				18-19
			TS			20
				TL		20
CU	ACC	TT				21
CU.NI.	INOX A2	TT				22
INOX A4	INOX A4	TT				23
INOX A2	INOX A2	TT				24
			TS			25
					TXL	25

<b>SPECIAL RIVETS</b>						
ALU	ACC			M'GRIP		26
ACC	ACC			M'GRIP		26
ALU	ACC			FIORE		27
				ERM		28
INOX A2	INOX			ERM		29
ALU	ALU			3ALI		29
ALU	ACC			TT-RAL		30-31
				SELF-SERVICE		32-33
CU	ACC			SELF-SERVICE		33
<b>ELECTRICAL APPLICATIONS - APPLICAZIONE ELETTRICHE - APPLICATIONS ÉLECTRIQUES - ELEKTRISCHE ANWENDUNG - ПРИМЕНЕНИЕ В ЭЛЕКТРИКЕ</b>						
CU	ACR			EL		34
ALU	ACC			EL		34

<b>STRUCTURAL RIVETS</b>						
ACC	ACC			SARIBULB ACC TT		35
INOX A2	INOX A2			SARIBULB INOX TT		35
ACC	ACC			SARIBOLT ACC TT		36
				SARIBOLT ACC TS		36
INOX A2	INOX A2			SARIBOLT INOX TT		37
				SARIBOLT INOX TS		37
ACC	ACC			ULTRABOLT ACC TT		38

WE CAN SUPPLY SPECIAL BLIND RIVETS ACCORDING TO CUSTOMER'S REQUIREMENTS  
 È POSSIBILE FORNIRE RIVETTI SPECIALI SECONDO SPECIFICHE DEL CLIENTE  
 IL EST POSSIBLE DE FOURNIR DES RIVETS SPECIAUX SUR DEMANDE  
 WIR KÖNNEN SPEZIELLE BLINDNIETE NACH KUNDENWUNSCH LIEFERN  
 ВОЗМОЖНА ПОСТАВКА СПЕЦИАЛЬНЫХ ВЫТЯЖНЫХ ЗАКЛЕПОК, СОГЛАСНО СПЕЦИФИКАЦИИ КЛИЕНТА

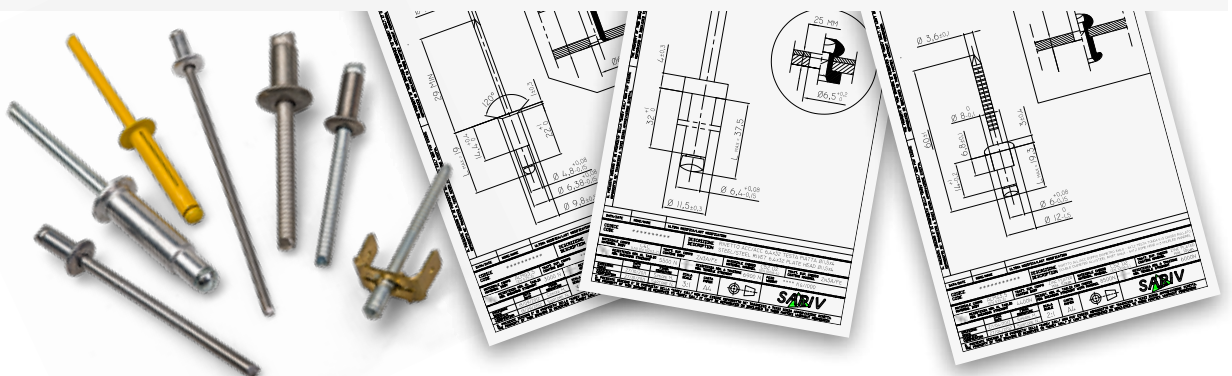



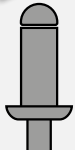

# SARIV ALU-ACC-TT

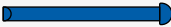

ALUMINIUM AL MG 3,5  
ALLUMINIO AL MG 3,5  
ALUMINIUM AL MG 3,5  
ALUMINIUM AL MG 3,5  
АЛЮМИНИЙ AL MG 3,5



ZINC PLATED STEEL  
ACCIAIO ZINCATO  
ACIER ZINGUE  
VERZINKTER STAHL  
ОЦИНКОВАННАЯ СТАЛЬ







DOME HEAD  
TESTA TONDA  
TÊTE PLATE  
FLACHRUNDKOPF  
СТАНДАРТНЫЙ БОРТИК

Ø	Ø mm	N	N
2.4	2.5 - 2.55	550	400
3.0	3.1 - 3.2	950	600
3.2	3.3 - 3.4	1.000	750
3.4	3.5 - 3.6	1.250	900

D1 mm	L mm	D2 mm	min-max mm	€/1000	1.000 Kg.	SARIV box Cod.	Pcs x SARIV box	Pcs Outer box	Industrial box Cod.	Pz x I-box
2.4	05	5	0.5 - 2	0.68		V010002405			I010002405	
	06		1 - 3	0.70		V010002406			I010002406	20.000
	07		2.5 - 4.5	0.71		V010002407	1.000	18.000	I010002407	
	08		4 - 6	0.72		V010002408			I010002408	
	10		6 - 8	0.79		V010002410			I010002410	18.000
	12		8 - 10	0.80		V010002412			I010002412	
3.0	05	6.5	0.5 - 2	0.94		V010003005			I010003005	17.000
	06		1 - 3	0.96		V010003006			I010003006	16.000
	07		2 - 4	0.97		V010003007			I010003007	
	08		3 - 5	0.98		V010003008		18.000	I010003008	15.000
	09		4 - 6	0.99		V010003009			I010003009	
	10		5 - 7	1.05		V010003010	1.000		I010003010	13.000
	11		6 - 8	1.06		V010003011			I010003011	12.000
	12		7 - 9	1.08		V010003012			I010003012	
	14		9 - 11	1.20		V010003014			I010003014	
	16		11 - 13	1.28		V010003016		12.000	I010003016	10.000
3.2	05	6.5	0.5 - 2	1.05		V010003205			I010003205	
	06		1 - 3	1.08		V010003206			I010003206	16.000
	07		2 - 4	1.12		V010003207			I010003207	
	08		3 - 5	1.16		V010003208		18.000	I010003208	15.000
	09		4 - 6	1.20		V010003209			I010003209	
	10		5 - 7	1.23		V010003210	1.000		I010003210	13.000
	11		6 - 8	1.25		V010003211			I010003211	12.000
	12		7 - 9	1.28		V010003212			I010003212	
	14		9 - 11	1.34		V010003214			I010003214	10.000
	16		11 - 13	1.39		V010003216		12.000	I010003216	
3.4	05	7	0.5 - 2	1.28		V010003405			I010003405	
	06		1 - 3	1.31		V010003406		18.000	I010003406	13.000
	07		2 - 4	1.34		V010003407			I010003407	
	09		4 - 6	1.37		V010003409			I010003409	
	11		6 - 8	1.52		V010003411	1.000		I010003411	11.000
	12		7 - 9	1.56		V010003412			I010003412	
	14		9 - 11	1.70		V010003414		12.000	I010003414	9.000
	16		11 - 13	1.74		V010003416			I010003416	8.000
18	13 - 15	1.78		V010003418			I010003418			

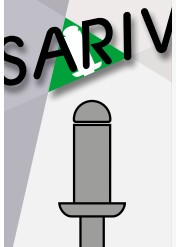

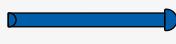
# SARIV ALU-ACC-TT

ALUMINIUM AL MG 3,5  
ALLUMINIO AL MG 3,5  
ALUMINIUM AL MG 3,5  
ALUMINIUM AL MG 3,5  
АЛЮМИНИЙ AL MG 3,5

ZINC PLATED STEEL  
ACCIAIO ZINCATO  
ACIER ZINGUE  
VERZINKTER STAHL  
ОЦИНКОВАННАЯ СТАЛЬ

DOME HEAD  
TESTA TONDA  
TÊTE PLATE  
FLACHRUNDKOPF  
СТАНДАРТНЫЙ БОРТИК

Ø	Ø mm	N	N
5.0	5.1 - 5.2	2.700	2.000
6.0	6.1 - 6.3	4.400	2.800
6.4	6.5 - 6.7	4.950	3.200
7.8	7.9 - 8.1	6.500	5.250

D1 mm	L mm	D2 mm	min-max mm	€/1000	1.000 Kg.	SARIV box Cod.	Pcs x SARIV box	Pcs Outer box	Industrial box Cod.	Pz x I-box
	06		0.5 - 2		2.29	V010005006	1.000	12.000	I010005006	
	08		2.5 - 4		2.38	V010005008			I010005008	7.000
	10		4.5 - 6		2.57	V010005010		9.000	I010005010	
	12		6.5 - 8		2.71	V010005012			I010005012	6.000
	14		7.5 - 10		3.02	V010005014			I010005014	
	16		9.5 - 12		3.08	V010005016			I010005016	5.000
5.0	18	9.5	11.5 - 14		3.30	V010005018	500		I010005018	
	20		13.5 - 16		3.39	V010005020		6.000	I010005020	
	22		15.5 - 18		3.43	V010005022			I010005022	4.000
	24		17.5 - 20		3.82	V010005024			I010005024	
	26		19.5 - 22		3.88	V010005026			I010005026	3.500
	28		21.5 - 24		4.10	V010005028	250	4.500	I010005028	
	30		23.5 - 26		4.17	V010005030			I010005030	3.000
	08		1 - 3		4.05	V010006008			I010006008	
	10		2.5 - 5		4.18	V010006010			I010006010	4.000
	12		4.5 - 7		4.34	V010006012	500	6.000	I010006012	
	14		5.5 - 9		4.65	V010006014			I010006014	
	16		6.5 - 10		4.75	V010006016			I010006016	3.500
6.0	18	12	9.5 - 13		5.16	V010006018		4.500	I010006018	
	20		11 - 14		5.31	V010006020			I010006020	
	22		12.5 - 17		5.41	V010006022	250		I010006022	3.000
	26		16.5 - 21		6.11	V010006026		3.000	I010006026	
	30		20.5 - 25		6.31	V010006030			I010006030	2.500
	35		24.5 - 30		7.03	V010006035			I010006035	
	40		29.5 - 35		7.55	V010006040	200	2.400	I010006040	2.000
	10		2 - 5		4.91	V010006410	500	6.000	I010006410	
	12		4 - 7		5.06	V010006412			I010006412	3.500
	16		6.5 - 10		5.71	V010006416		4.500	I010006416	
	18		9.5 - 13		5.82	V010006418			I010006418	3.000
6.4	22	13	12.5 - 17		6.80	V010006422	250		I010006422	2.500
	26		16.5 - 21		7.04	V010006426		3.000	I010006426	
	30		20.5 - 25		7.30	V010006430			I010006430	2.000
	35		24.5 - 30		8.13	V010006435			I010006435	1.500
	40		29.5 - 35		8.73	V010006440	200	2.400	I010006440	
	15		4 - 9		8.00	V010007815			I010007815	
	18		9.5 - 13		8.40	V010007818	250	3.000	I010007818	2.000
7.8	22	14	12.5 - 17		8.90	V010007822			I010007822	
	26		16.5 - 21		10.00	V010007826			I010007826	1.500
	30		20.5 - 25		10.90	V010007830	200	2.400	I010007830	
	35		24.5 - 30		12.00	V010007835			I010007835	1.000

# SARIV ALU-ACC-TS

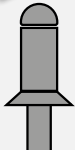

ALUMINIUM AL MG 3,5  
ALLUMINIO AL MG 3,5  
ALUMINIUM AL MG 3,5  
ALUMINIUM AL MG 3,5  
АЛЮМИНИЙ AL MG 3,5

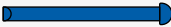

ZINC PLATED STEEL  
ACCIAIO ZINCATO  
ACIER ZINGUE  
VERZINKTER STAHL  
ОЦИНКОВАННАЯ СТАЛЬ







COUNTERSUNK HEAD (120°)  
TESTA SVASATA (120°)  
TÊTE FRAISÉE (120°)  
SENKKOPF (120°)  
ПОТайНОЙ БОРТИК (120°)

Ø	Ø mm	N	N
2.4	2.5 - 2.55	550	400
3.0	3.1 - 3.2	950	600
3.2	3.3 - 3.4	1.000	750
4.0	4.1 - 4.2	1.750	1.200
4.8	4.9 - 5.0	2.600	1.850

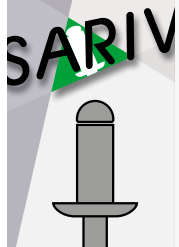
D1 mm	L mm	D2 mm	min-max mm	€/1000	1.000 Kg.	SARIV box Cod.	Pcs x SARIV box	Pcs Outer box	Industrial box Cod.	Pz x I-box
	06		2 - 4		0.70	V010102406			I010102406	20.000
2.4	08	5	4 - 6		0.73	V010102408	1.000	18.000	I010102408	
	10		6 - 8		0.77	V010102410			I010102410	18.000
	07		2 - 4		1.02	V010103007			I010103007	16.000
3.0	09	6	4 - 6		1.04	V010103009	1.000	18.000	I010103009	15.000
	11		6 - 8		1.06	V010103011			I010103011	12.000
	07		2 - 4		1.07	V010103207			I010103207	16.000
3.2	09	6	4 - 6		1.09	V010103209	1.000	18.000	I010103209	15.000
	11		6 - 8		1.24	V010103211			I010103211	12.000
	07		2.5 - 4		1.59	V010104007			I010104007	10.000
4.0	09		3.5 - 6		1.68	V010104009			I010104009	
	11		5.5 - 8		1.83	V010104011	1.000	12.000	I010104011	
	12	7.5	7.5 - 9		1.85	V010104012			I010104012	8.000
	14		8.5 - 11		2.05	V010104014			I010104014	
	16		10.5 - 13		2.10	V010104016			I010104016	7.000
	18		12.5 - 15		2.30	V010104018	500	9.000	I010104018	6.000
4.8	20		14.5 - 17		2.33	V010104020			I010104020	
	07		2.5 - 4		2.26	V010104807	1.000	12.000	I010104807	8.000
	09		3.5 - 5		2.37	V010104809			I010104809	7.000
	11		4.5 - 7		2.57	V010104811		9.000	I010104811	
	12		6.5 - 8		2.63	V010104812			I010104812	6.000
	14	9	7.5 - 10		2.92	V010104814			I010104814	
	16		9.5 - 12		2.99	V010104816	500		I010104816	5.000
	18		11.5 - 14		3.32	V010104818		6.000	I010104818	
	20		13.5 - 16		3.40	V010104820			I010104820	
	26		19.5 - 22		3.89	V010104826			I010104826	4.000
	30		23.5 - 26		4.08	V010104830	250	4.500	I010104830	3.500

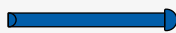
# SARIV ALU-ACC-TL

ALUMINIUM AL MG 3,5  
ALLUMINIO AL MG 3,5  
ALUMINIUM AL MG 3,5  
ALUMINIUM AL MG 3,5  
АЛЮМИНИЙ AL MG 3,5

ZINC PLATED STEEL  
ACCIAIO ZINCATO  
ACIER ZINGUE  
VERZINKTER STAHL  
ОЦИНКОВАННАЯ СТАЛЬ

LARGE HEAD  
TESTA LARGA  
TÊTE LARGE  
GROSSKOPF  
УВЕЛИЧЕННЫЙ БОРТИК

Ø	Ø mm	N	N
4.0	4.1 - 4.2	1.750	1.200
4.8	4.9 - 5.0	2.600	1.850
5.0	5.1 - 5.2	2.700	2.000

D1 mm	L mm	D2 mm	min-max mm	€/1000	1.000 Kg.	SARIV box Cod.	Pcs x SARIV box	Pcs Outer box	Industrial box Cod.	Pz x I-box
4.0	08	10	2 - 4		1.69	V010204008			I010204008	8.000
	10		5 - 6.5		1.85	V010204010	1.000	12.000	I010204010	
	12		7 - 8.5		1.95	V010204012			I010204012	7.000
	14		8 - 10.5		2.18	V010204014		9.000	I010204014	
	16		10 - 12.5		2.23	V010204016	500		I010204016	6.000
	20		13 - 16.5		2.43	V010204020		6.000	I010204020	
4.8	08	14	2.5 - 4		2.65	V010204808			I010204808	5.000
	10		4.5 - 6		2.91	V010204810			I010204810	
	12		5.5 - 8		3.10	V010204812	500	6.000	I010204812	
	14		7.5 - 10		3.32	V010204814			I010204814	4.000
	16		9.5 - 12		3.42	V010204816			I010204816	
	18		11.5 - 14		3.72	V010204818		4.500	I010204818	3.500
	20		13.5 - 16		3.80	V010204820			I010204820	
	24		17.5 - 20		4.25	V010204824			I010204824	
	26		19.5 - 22		4.29	V010204826	250		I010204826	3.000
	30		23.5 - 26		4.57	V010204830		3.000	I010204830	
5.0	35		25.5 - 31		4.98	V010204835			I010204835	2.500
	40		29.5 - 36		5.45	V010204840			I010204840	2.000
	10	14	4 - 6		3.00	V010205010			I010205010	5.000
	12		6 - 8		3.20	V010205012	500	6.000	I010205012	
	14		7 - 10		3.40	V010205014			I010205014	4.000
	16		9 - 12		3.50	V010205016			I010205016	
	18		11 - 14		3.80	V010205018		4.500	I010205018	3.500
	20		13 - 16		3.90	V010205020	250		I010205020	
25	16 - 21			4.35	V010205025		3.000	I010205025	3.000	
30	21 - 26			4.65	V010205030			I010205030		

# SARIV ALU-ACC-TXL

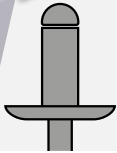

ALUMINIUM AL MG 3,5  
 ALLUMINIO AL MG 3,5  
 ALUMINIUM AL MG 3,5  
 ALUMINIUM AL MG 3,5  
 АЛЮМИНИЙ AL MG 3,5

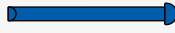

ZINC PLATED STEEL  
 ACCIAIO ZINCATO  
 ACIER ZINGUE  
 VERZINKTER STAHL  
 ОЦИНКОВАННАЯ СТАЛЬ



EXTRA-LARGE HEAD  
 TESTA EXTRA-LARGA  
 TÊTE EXTRA-LARGE  
 EXTRA-GROSSKOPF  
 ЭКСТРА УВЕЛИЧЕННЫЙ БОРТИК

Ø	Ø mm	N	N
3.2	3.3 - 3.4	1.000	750
4.0	4.1 - 4.2	1.750	1.200
4.8	4.9 - 5.0	2.600	1.850

D1 mm	L mm	D2 mm	min-max mm	€/1000	1.000 Kg.	SARIV box Cod.	Pcs x SARIV box	Pcs Outer box	Industrial box Cod.	Pz x I-box
3.2	08	10	3 - 5		1.19	V010303208			I010303208	
	10		5 - 7		1.37	V010303210	1.000	12.000	I010303210	8.000
	12		7 - 9		1.42	V010303212			I010303212	
	14		9 - 11		1.52	V010303214	500	6.000	I010303214	
	16		11 - 13		1.55	V010303216			I010303216	7.000
4.0	08	12	2 - 4		1.89	V010304008			I010304008	7.000
	10		5 - 6.5		2.06	V010304010		9.000	I010304010	
	12		7 - 8.5		2.15	V010304012	500		I010304012	6.000
	14		8 - 10.5		2.36	V010304014			I010304014	
	16		10 - 12.5		2.38	V010304016		6.000	I010304016	5.000
4.8	20	16	13 - 16.5		2.58	V010304020			I010304020	
	10		4.5 - 6		3.13	V010304810	500	6.000	I010304810	4.000
	12		5.5 - 8		3.30	V010304812			I010304812	
	14		7.5 - 10		3.65	V010304814		4.500	I010304814	
	16		9.5 - 12		3.68	V010304816			I010304816	3.000
	18		11.5 - 14		3.86	V010304818			I010304818	
	20		13.5 - 16		3.92	V010304820	250		I010304820	
	24		15.5 - 18		4.42	V010304824		3.000	I010304824	
	26		17.5 - 20		4.48	V010304826			I010304826	2.500
	30		21.5 - 24		4.75	V010304830			I010304830	
35	25.5 - 31		5.20	V010304835			I010304835	2.000		
40	30.5 - 36		5.65	V010304840	200	2.400	I010304840			

# SARIV ALU-INOX A2-TT



ALUMINIUM AL MG 3,5  
 ALLUMINIO AL MG 3,5  
 ALUMINIUM AL MG 3,5  
 ALUMINIUM AL MG 3,5  
 АЛЮМИНИЙ AL MG 3,5



INOX A2  
 INOX A2  
 INOX A2  
 EDELSTAHL A2  
 НЕРЖ.СТАЛЬ А2





DOME HEAD  
 TESTA TONDA  
 TÊTE PLATE  
 FLACHRUNDKOPF  
 СТАНДАРТНЫЙ БОРТИК

Ø	Ø mm	N	N
3.0	3.1 - 3.2	950	600
3.2	3.3 - 3.4	1.000	750
4.0	4.1 - 4.2	1.750	1.200
4.8	4.9 - 5.0	2.600	1.850

D1 mm	L mm	D2 mm	min-max mm	€/1000	1.000 Kg.	SARIV box Cod.	Pcs x SARIV box	Pcs Outer box	Industrial box Cod.	Pz x I-box
3.0	06	6.5	1 - 3		0.95	V020003006	1.000	18.000	I020003006	16.000
	08		3 - 5		0.97	V020003008			I020003008	15.000
	10		5 - 7		1.11	V020003010			I020003010	13.000
3.2	06	6.5	1 - 3		1.07	V020003206	1.000	18.000	I020003206	16.000
	08		3 - 5		1.10	V020003208			I020003208	15.000
	10		5 - 7		1.21	V020003210			I020003210	13.000
	12		7 - 9		1.25	V020003212			I020003212	12.000
	4.0	8	1 - 2.5		1.62	V020004006	1.000	12.000	I020004006	10.000
			08		3 - 4.5	1.66			V020004008	
10			5 - 6.5		1.84	V020004010			I020004010	
	12		7 - 8.5		1.88	V020004012			I020004012	8.000
	14		8 - 10.5		2.16	V020004014			I020004014	
	16		10 - 12.5		2.20	V020004016	500	9.000	I020004016	7.000
	20		14 - 16.5		2.40	V020004020			I020004020	6.000
	4.8	9.5	2 - 4		2.31	V020004808	1.000	12.000	I020004808	7.000
			10		4.5 - 6	2.66	V020004810		9.000	I020004810
12			6.5 - 8		2.77	V020004812			I020004812	6.000
	14		7.5 - 10		3.04	V020004814			I020004814	
	16		9.5 - 12		3.12	V020004816	500		I020004816	5.000
	18		11.5 - 14		3.33	V020004818		6.000	I020004818	
	20		13.5 - 16		3.42	V020004820			I020004820	
	26		19.5 - 22		3.90	V020004826			I020004826	4.000
	30		23.5 - 26		4.20	V020004830	250	4.500	I020004830	3.000

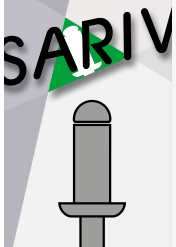
**SARIV ALU-ALU-TT**

ALUMINIUM AL MG 2,5  
ALLUMINIO AL MG 2,5  
ALUMINIUM AL MG 2,5  
ALUMINIUM AL MG 2,5  
АЛЮМИНИЙ AL MG 2,5

ALUMINIUM AL MG 5  
ALLUMINIO AL MG 5  
ALUMINIUM AL MG 5  
ALUMINIUM AL MG 5  
АЛЮМИНИЙ AL MG 5

DOME HEAD  
TESTA TONDA  
TÊTE PLATE  
FLACHRUNDKOPF  
СТАНДАРТНЫЙ БОРТИК





Ø	Ø mm	N	N
3.2	3.3 - 3.4	850	600
4.0	4.1 - 4.2	1.200	800
4.8	4.9 - 5.0	2.100	1.700

D1 mm	L mm	D2 mm	min-max mm	€/1000	Kg.	SARIV box Cod.	Pcs x SARIV box	Pcs Outer box	Industrial box Cod.	Pz x I-box
3.2	6	6.5	1 - 3		0.51	V030003206			I030003206	16.000
	8		3 - 5		0.54	V030003208	1.000	18.000	I030003208	15.000
	10		5 - 7		0.61	V030003210			I030003210	12.000
	12		7 - 9		0.64	V030003212			I030003212	
4.0	6	8	1 - 2.5		0.80	V030004006			I030004006	
	8		3 - 4.5		0.84	V030004008	1.000	12.000	I030004008	10.000
	10		5 - 6.5		0.93	V030004010			I030004010	
	12		7 - 8.5		1.00	V030004012			I030004012	8.000
	14		8 - 10.5		1.08	V030004014			I030004014	
	16		10 - 13		1.15	V030004016	500	9.000	I030004016	6.000
	20		13.5 - 16		1.31	V030004020		6.000	I030004020	5.000
	8		2.5 - 4		1.27	V030004808	1000	12.000	I030004808	7.000
4.8	10	9.5	4.5 - 6		1.37	V030004810		9.000	I030004810	
	12		6.5 - 8		1.49	V030004812			I030004812	6.000
	14		7.5 - 10		1.61	V030004814	500		I030004814	
	16		9.5 - 12		1.68	V030004816		6.000	I030004816	5.000
	18		11.5 - 14		1.82	V030004818			I030004818	
	20		13.5 - 16.5		1.87	V030004820			I030004820	

**ООО «АЛЬЯНС» (499) 714-28-28**  
**WWW.ИНСТРУМЕНТЫ-ВСЕМ.РФ**  
**(499) 714-28-28 s7142828@yandex.ru**

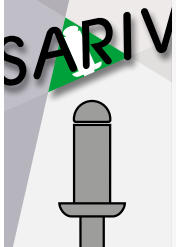

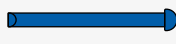
# SARIV ACC-ACC-TT

ZINC PLATED STEEL  
ACCIAIO ZINCATO  
ACIER ZINGUE  
VERZINKTER STAHL  
ОЦИНКОВАННАЯ СТАЛЬ

ZINC PLATED STEEL  
ACCIAIO ZINCATO  
ACIER ZINGUE  
VERZINKTER STAHL  
ОЦИНКОВАННАЯ СТАЛЬ

DOMED HEAD  
TESTA TONDA  
TÊTE PLATE  
FLACHRUNDKOPF  
СТАНДАРТНЫЙ БОРТИК

Ø	Ø mm	N	N
3.0	3.1 - 3.2	1.400	1.050
3.2	3.3 - 3.4	1.500	1.100
4.0	4.1 - 4.2	2.500	1.800
4.8	4.9 - 5.0	3.700	2.900

D1 mm	L mm	D2 mm	min-max mm	€/1000	Kg.	SARIV box Cod.	Pcs x SARIV box	Pcs Outer box	Industrial box Cod.	Pz x I-box
3.0	06	6.5	0.5 - 3		1.40	V110003006			I110003006	
	07		3 - 4		1.45	V110003007		12.000	I110003007	15.000
	08		4 - 5		1.50	V110003008			I110003008	
	09		5 - 6		1.55	V110003009	1.000		I110003009	13.000
	10		6 - 7		1.60	V110003010		8.000	I110003010	
	12		7 - 9		1.70	V110003012			I110003012	12.000
3.2	06	6.5	0.5 - 3		1.50	V110003206			I110003206	
	07		3 - 4		1.55	V110003207		12.000	I110003207	15.000
	08		4 - 5		1.65	V110003208			I110003208	
	09		5 - 6		1.70	V110003209			I110003209	13.000
	10		6 - 7		1.77	V110003210	1.000		I110003210	
	11		7 - 8		1.85	V110003211		8.000	I110003211	12.000
12	8 - 9		1.90	V110003212			I110003212			
4.0	16	8	11 - 13		2.14	V110003216			I110003216	10.000
	06		1 - 2.5		2.35	V110004006			I110004006	
	07		2 - 3.5		2.40	V110004007			I110004007	
	08		3 - 4.5		2.50	V110004008			I110004008	10.000
	09		4 - 5.5		2.58	V110004009		8.000	I110004009	
	10		5 - 6.5		2.60	V110004010	1.000		I110004010	
	11		6 - 7.5		2.74	V110004011			I110004011	8.000
	12		7 - 8.5		2.86	V110004012			I110004012	
	14		8 - 10.5		2.97	V110004014		6.000	I110004014	7.000
	16		10 - 12.5		3.13	V110004016			I110004016	
4.8	18	9.5	12 - 14.5		3.41	V110004018			I110004018	6.000
	20		14 - 16.5		3.52	V110004020	500	4.000	I110004020	
	24		16 - 20.5		3.60	V110004024			I110004024	5.000
	30		20 - 26.5		4.00	V110004030			I110004030	4.000
	06		1 - 2.5		3.60	V110004806			I110004806	
	07		1.5 - 3		3.64	V110004807			I110004807	
	08		2.5 - 4		3.73	V110004808			I110004808	7.000
	09		3.5 - 5		3.90	V110004809		6.000	I110004809	
	10		4.5 - 6		4.01	V110004810			I110004810	
	11		5.5 - 7		4.12	V110004811			I110004811	6.000
4.8	12	9.5	6.5 - 8		4.24	V110004812	500		I110004812	
	14		7.5 - 10		4.69	V110004814			I110004814	
	16		9.5 - 12		4.83	V110004816			I110004816	5.000
	18		11.5 - 14		5.32	V110004818		4.000	I110004818	
	20		13.5 - 16		5.50	V110004820			I110004820	4.000
	24		15.5 - 20		6.20	V110004824		3.000	I110004824	
	26		17.5 - 22		6.53	V110004826			I110004826	3.000
	30		19.5 - 26		7.20	V110004830	250	2.000	I110004830	
35	25 - 31		8.14	V110004835			I110004835	2.000		
40	31 - 36		8.50	V110004840	200	1.600	I110004840	1.500		

# SARIV ACC-ACC-TT

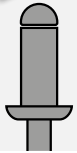

ZINC PLATED STEEL  
ACCIAIO ZINCATO  
ACIER ZINGUE  
VERZINKTER STAHL  
ОЦИНКОВАННАЯ СТАЛЬ

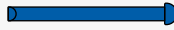

ZINC PLATED STEEL  
ACCIAIO ZINCATO  
ACIER ZINGUE  
VERZINKTER STAHL  
ОЦИНКОВАННАЯ СТАЛЬ



DOME HEAD  
TESTA TONDA  
TÊTE PLATE  
FLACHRUNDKOPF  
СТАНДАРТНЫЙ БОРТИК

Ø	Ø mm	N	N
5.0	5.1 - 5.3	4.000	3.200
6.0	6.1 - 6.3	6.000	4.300
6.4	6.5 - 6.7	6.500	4.900

D1 mm	L mm	D2 mm	min-max mm	€/1000	1.000 Kg.	SARIV box Cod.	Pcs x SARIV box	Pcs Outer box	Industrial box Cod.	Pz x I-box
5.0	08	9.5	2 - 4	4.80	3.80	V110005008	500	6.000	I110005008	7.000
	10		4.5 - 6							
	12	6.5 - 8	4.35	V110005012	I110005012					
	14	7.5 - 10	4.80	V110005014	I110005014	5.000				
	16	9.5 - 12	4.95	V110005016	I110005016	4.000				
	18	11.5 - 14	5.45	V110005018	I110005018	4.000				
	20	13.5 - 16	5.65	V110005020	I110005020					
6.0	08	12	1 - 3	8.74	6.40	V110006008	250	3.000	I110006008	4.000
	10		2 - 4							
	12	3.5 - 7	7.00	V110006012	I110006012					
	15	6.5 - 10	7.73	V110006015	I110006015	3.500				
	18	9.5 - 13	8.74	V110006018	I110006018	3.000				
	22	12.5 - 17	9.31	V110006022	I110006022	2.000				
	26	16.5 - 21	9.79	V110006026	I110006026	2.500				
30	20.5 - 25	11.20	V110006030	I110006030						
6.4	08	13	1 - 3	11.76	7.78	V110006408	250	3.000	I110006408	3.000
	10		2 - 5							
	12	3 - 7	8.30	V110006412	I110006412					
	15	6.5 - 10	9.10	V110006415	I110006415					
	18	9.5 - 13	9.50	V110006418	I110006418					
	22	12.5 - 17	11.08	V110006422	I110006422	2.000				
	26	16.5 - 21	11.76	V110006426	I110006426	2.500				
30	20.5 - 25	12.35	V110006430	I110006430						

# SARIV ACC-ACC-TS

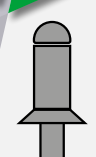

ZINC PLATED STEEL  
ACCIAIO ZINCATO  
ACIER ZINGUÉ  
VERZINKTER STAHL  
ОЦИНКОВАННАЯ СТАЛЬ



ZINC PLATED STEEL  
ACCIAIO ZINCATO  
ACIER ZINGUÉ  
VERZINKTER STAHL  
ОЦИНКОВАННАЯ СТАЛЬ

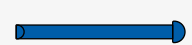

COUNTERSUNK HEAD (120°)  
TESTA SVASATA (120°)  
TÊTE FRAISÉE (120°)  
SENKKOPF (120°)  
ПОТайНОЙ БОРТИК (120°)



Ø	Ø mm	N	N
3.2	3.3 - 3.4	1.500	1.100
4.0	4.1 - 4.2	2.500	1.800
4.8	4.9 - 5.0	3.700	2.900

D1 mm	L mm	D2 mm	min-max mm	€/1000	1.000 Kg.	SARIV box Cod.	Pcs x SARIV box	Pcs Outer box	Industrial box Cod.	Pz x I-box
3.2	06		1 - 3		1.55	V110103206			I110103206	15.000
	08	6	3 - 5		1.65	V110103208	1.000	12.000	I110103208	
	10		5 - 7		1.77	V110103210			I110103210	13.000
4.0	08		2.5 - 4.5		2.55	V110104008			I110104008	10.000
	10	7.5	4.5 - 6.5		2.60	V110104010	1.000	8.000	I110104010	
	12		6.5 - 8.5		2.86	V110104012			I110104012	8.000
	14		8.5 - 10.5		2.97	V110104014	500	6.000	I110104014	
4.8	08		2 - 4		3.60	V110104808			I110104808	7.000
	10		4 - 6		4.00	V110104810		6.000	I110104810	
	12	9	6 - 8		4.24	V110104812	500		I110104812	6.000
	14		7 - 9		4.68	V110104814			I110104814	5.000
	16		7.5 - 11		4.83	V110104816		4.000	I110104816	
	20		11 - 15		5.32	V110104820			I110104820	4.000

# SARIV ACC-ACC-TL

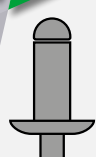

ZINC PLATED STEEL  
ACCIAIO ZINCATO  
ACIER ZINGUÉ  
VERZINKTER STAHL  
ОЦИНКОВАННАЯ СТАЛЬ



ZINC PLATED STEEL  
ACCIAIO ZINCATO  
ACIER ZINGUÉ  
VERZINKTER STAHL  
ОЦИНКОВАННАЯ СТАЛЬ



LARGE HEAD  
TESTA LARGA  
TÊTE LARGE  
GROSSKOPF  
УВЕЛИЧЕННЫЙ БОРТИК



Ø	Ø mm	N	N
4.8	4.9 - 5.0	3.700	2.900

D1 mm	L mm	D2 mm	min-max mm	€/1000	1.000 Kg.	SARIV box Cod.	Pcs x SARIV box	Pcs Outer box	Industrial box Cod.	Pz x I-box
4.8	10		4 - 6		5.25	V110204810			I110204810	4.000
	12		6 - 8		5.50	V110204812	500	4.000	I110204812	
	14	14	7.5 - 10		5.95	V110204814			I110204814	3.500
	16		9.5 - 12		6.10	V110204816			I110204816	
	18		11.5 - 14		6.60	V110204818	250	2.000	I110204818	3.000
	20		13.5 - 16		6.75	V110204820			I110204820	

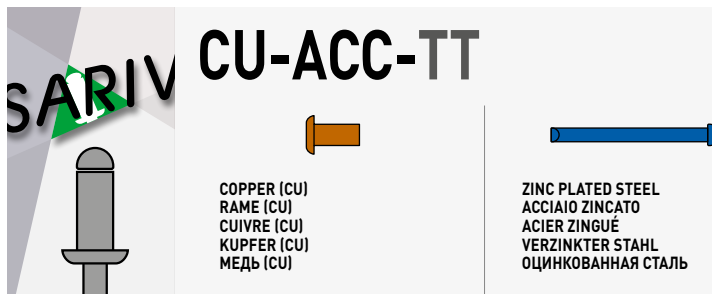

# SARIV CU-ACC-TT



COPPER (CU)  
RAME (CU)  
CUIVRE (CU)  
KUPFER (CU)  
МЕДЬ (CU)

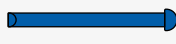

ZINC PLATED STEEL  
ACCIAIO ZINCATO  
ACIER ZINGUE  
VERZINKTER STAHL  
ОЦИНКОВАННАЯ СТАЛЬ





DOME HEAD  
TESTA TONDA  
TÊTE PLATE  
FLACHRUNDKOPF  
СТАНДАРТНЫЙ БОРТИК

Ø	Ø mm	N	N
3.0	3.1 - 3.2	1.050	700
3.2	3.3 - 3.4	1.200	850
3.4	3.5 - 3.6	1.350	1.000
4.0	4.1 - 4.2	2.000	1.400
4.8	4.9 - 5.0	2.700	1.950

D1 mm	L mm	D2 mm	min-max mm	€/1000	1.000 Kg.	SARIV box Cod.	Pcs x SARIV box	Pcs Outer box	Industrial box Cod.	Pz x I-box
3.0	06	6.5	1 - 3		1.47	V210003006	1.000	12.000	I210003006	15.000
	07		2 - 4		1.50	V210003007			I210003007	
	09		4 - 6		1.54	V210003009			I210003009	14.000
	11		6 - 8		1.64	V210003011			I210003011	12.000
3.2	07	6.5	2 - 4		1.63	V210003207	1.000	12.000	I210003207	15.000
	09		4 - 6		1.69	V210003209			I210003209	14.000
	11		6 - 8		1.92	V210003211			I210003211	12.000
	12		8 - 9		1.98	V210003212			I210003212	
3.4	07	7	1 - 3		1.76	V210003407	1.000	12.000	I210003407	15.000
	09		4 - 6		1.85	V210003409			I210003409	13.000
	11		6 - 8		2.12	V210003411			I210003416	11.000
4.0	06	8	1 - 2.5		2.32	V210004006	1.000	8.000	I210004006	
	07		2 - 3.5		2.41	V210004007			I210004007	10.000
	09		3 - 5		2.67	V210004009			I210004009	
	11		5 - 7		2.80	V210004011			I210004011	8.000
	12		5.5 - 8		2.85	V210004012			I210004012	
	16		8 - 11		3.38	V210004016			I210004016	7.000
4.8	20	9.5	12 - 16		3.77	V210004020	500	6.000	I210004020	6.000
	12		5.5 - 8		4.35	V210004812			I210004812	6.000
	14		7.5 - 10		4.84	V210004814			I210004814	5.000
	16		9 - 12		4.96	V210004816			I210004816	

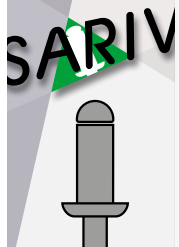
# SARIV CU.NI-INOX A2-TT

**COPPER-NI. CU 80% NI 20%**  
**CU.NICKEL CU 80% NI 20%**  
**CU.NICKEL CU 80% NI 20%**  
**KUPFER-NI. CU 80% NI 20%**  
**МЕДНОНИКЕЛЕВЫЙ СПЛАВ CU 80% NI 20%**

**INOX A2**  
**INOX A2**  
**INOX A2**  
**EDELSTAHL A2**  
**НЕРЖ.СТАЛЬ A2**

**DOME HEAD**  
**TESTA TONDA**  
**TÊTE PLATE**  
**FLACHRUNDKOPF**  
**СТАНДАРТНЫЙ БОРТИК**

Ø	Ø mm	N	N
3.2	3.3 - 3.4	1.800	1.200
4.0	4.1 - 4.2	2.350	1.700
4.8	4.9 - 5.0	3.700	2.400

D1 mm	L mm	D2 mm	min-max mm	€/1000	1.000 Kg.	SARIV box Cod.	Pcs x SARIV box	Pcs Outer box	Industrial box Cod.	Pz x I-box
3.2	06	6.5	0.5 - 3		1.67	V420003206			I420003206	15.000
	07		3 - 4		1.69	V420003207		12.000	I420003207	
	09		4 - 6		1.73	V420003209	1.000		I420003209	14.000
	11		6 - 8		1.90	V420003211		8.000	I420003211	12.000
	12		8 - 9		2.00	V420003212			I420003212	
4.0	07	8	2 - 3.5		2.51	V420004007			I420004007	10.000
	09		3 - 5.5		2.60	V420004009	1.000	8.000	I420004009	
	11		5 - 7.5		2.88	V420004011			I420004011	8.000
	14		8 - 10.5		3.25	V420004014			I420004014	
	16		10 - 12.5		3.36	V420004016	500	6.000	I420004016	7.000
4.8	18	9.5	12 - 14.5		3.48	V420004018			I420004018	6.000
	07		0.5 - 3		3.82	V420004807			I420004807	7.000
	09		2.5 - 5		3.95	V420004809		6.000	I420004809	
	12		5.5 - 8		4.50	V420004812	500		I420004812	6.000
	16		9.5 - 12		4.95	V420004816			I420004816	5.000
	18		11.5 - 14		5.53	V420004818		4.000	I420004818	
	20		13.5 - 16		5.65	V420004820			I420004820	4.000

**SARIV INOX A4-INOX A4-TT**

INOX A4  
INOX A4  
INOX A4  
EDELSTAHL A4  
НЕРЖ.СТАЛЬ А4

INOX A4  
INOX A4  
INOX A4  
EDELSTAHL A4  
НЕРЖ.СТАЛЬ А4

DOMO HEAD  
TESTA TONDA  
TÊTE PLATE  
FLACHRUNDKOPF  
СТАНДАРТНЫЙ БОРТИК

Ø	Ø mm	N	N
3.2	3.3 - 3.4	2.600	2.200
4.0	4.1 - 4.2	4.100	3.300
4.8	4.9 - 5.0	6.000	4.800

D1 mm	L mm	D2 mm	min-max mm	€/1000	1.000 Kg.	SARIV box Cod.	Pcs x SARIV box	Pcs Outer box	Industrial box Cod.	Pz x I-box
3.2	06	6.5	0.5 - 3		1.60	V860003206		12.000	I860003206	15.000
	08		3 - 5		1.65	V860003208	1.000		I860003208	
	10		4 - 6		1.85	V860003210		8.000	I860003210	13.000
4.0	06	8	1 - 2.5		2.40	V860004006			I860004006	
	08		2 - 4.5		2.50	V860004008			I860004008	10.000
	10		4 - 6.5		2.60	V860004010	1.000	8.000	I860004010	
	12		6.5 - 8		2.85	V860004012			I860004012	8.000
	14		7 - 9.5		3.15	V860004014	500	6.000	I860004014	
4.8	08	9.5	2.5 - 4		3.95	V860004808			I860004808	7.000
	10		4 - 6		4.10	V860004810	500	6.000	I860004810	
	12		6 - 8		4.45	V860004812			I860004812	6.000
	14		7.5 - 10		4.90	V860004814		4.000	I860004814	5.000

**ООО «АЛЬЯНС» (499) 714-28-28**  
**WWW.ИНСТРУМЕНТЫ-ВСЕМ.РФ**

# SARIV INOX A2-INOX A2-TT

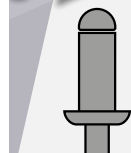

INOX A2  
INOX A2  
INOX A2  
EDELSTAHL A2  
НЕРЖ.СТАЛЬ A2



INOX A2  
INOX A2  
INOX A2  
EDELSTAHL A2  
НЕРЖ.СТАЛЬ A2



DOME HEAD  
TESTA TONDA  
TÊTE PLATE  
FLACHRUNDKOPF  
СТАНДАРТНЫЙ БОРТИК

Ø	Ø mm	N	N
3.0	3.1 - 3.2	2.100	1.900
3.2	3.3 - 3.4	2.400	1.900
4.0	4.1 - 4.2	4.000	3.200
4.8	4.9 - 5.0	5.800	4.700
5.0	5.1 - 5.2	6.600	5.200
6.4	6.5 - 6.7	9.500	7.500

D1 mm	L mm	D2 mm	min-max mm	€/1000	1.000 Kg.	SARIV box Cod.	Pcs x SARIV box	Pcs Outer box	Industrial box Cod.	Pz x I-box
3.0	06	6.5	1 - 3		1.30	V620003006	1.000	12.000	I620003006	15.000
	08		3 - 5		1.35	V620003008		8.000	I620003008	
	10		5 - 7		1.45	V620003010			I620003010	13.000
	12		7 - 8.5		1.50	V620003012			I620003012	12.000
3.2	06	6.5	1 - 3		1.60	V620003206	1.000	12.000	I620003206	15.000
	08		3 - 5		1.65	V620003208			I620003208	
	10		4 - 6		1.85	V620003210			I620003210	13.000
	12		6 - 8		1.90	V620003212			I620003212	12.000
	15		8 - 11		2.20	V620003215			I620003215	8.000
4.0	06	8	1 - 3		2.40	V620004006	500		I620004006	10.000
	08		2 - 4.5		2.50	V620004008		8.000	I620004008	
	10		4 - 6.5		2.60	V620004010			I620004010	
	12		6.5 - 8		2.85	V620004012			I620004012	8.000
	14		7 - 9.5		3.15	V620004014			I620004014	
	16		9 - 12		3.30	V620004016			I620004016	7.000
4.8	20	9.5	12 - 15.5		3.70	V620004020	250	4.000	I620004020	6.000
	06		1 - 3		3.80	V620004806			I620004806	
	08		2.5 - 4		3.95	V620004808		6.000	I620004808	7.000
	10		4 - 6		4.10	V620004810			I620004810	
	12		6 - 8		4.45	V620004812		500	I620004812	6.000
	14		7.5 - 10		4.90	V620004814			I620004814	
	16		9.5 - 12		5.05	V620004816			I620004816	5.000
	18		11.5 - 14		5.50	V620004818			I620004818	
5.0	20	9.5	13.5 - 16		5.60	V620004820	500		I620004820	4.000
	24		15 - 19.5		6.35	V620004824		3.000	I620004824	
	08		2 - 4		4.05	V620005008			I620005008	7.000
	10		4 - 6		4.20	V620005010		6.000	I620005010	6.000
6.4	12	13	5 - 8		4.55	V620005012	250		I620005012	
	16		8 - 12		5.15	V620005016		4.000	I620005016	5.000
	12		3.5 - 7		8.90	V620006412		3.000	I620006412	
	15		6.5 - 10		9.45	V620006415			I620006415	3.000
	18		9.5 - 13		9.95	V620006418			I620006418	
	22		12.5 - 17		11.60	V620006422		2.000	I620006422	
6.4	26	13	16.5 - 21		12.00	V620006426	250		I620006426	2.500
	30		20.5 - 25		12.60	V620006430			I620006430	

# SARIV INOX A2-INOX A2-TS

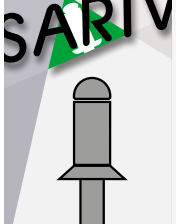
INOX A2  
INOX A2  
INOX A2  
EDELSTAHL A2  
НЕРЖ.СТАЛЬ A2

INOX A2  
INOX A2  
INOX A2  
EDELSTAHL A2  
НЕРЖ.СТАЛЬ A2

COUNTERSUNK HEAD (120°)  
TESTA SVASATA (120°)  
TÊTE FRAISÉE (120°)  
SENKKOPF (120°)  
ПОТАЙНОЙ БОРТИК (120°)

Ø	Ø mm	N	N
3.2	3.3 - 3.4	2.400	1.900
4.0	4.1 - 4.2	4.000	3.200
4.8	4.9 - 5.0	5.800	4.700

D1 mm	L mm	D2 mm	min-max mm	€/1000	1.000 Kg.	SARIV box Cod.	Pcs x SARIV box	Pcs Outer box	Industrial box Cod.	Pz x I-box
3.2	06		1 - 3		1.52	V620103206		12.000	I620103206	15.000
	08	6	3 - 5		1.55	V620103208	1.000		I620103208	13.000
	10		5 - 7		1.75	V620103210		8.000	I620103210	12.000
4.0	08		2.5 - 4.5		2.30	V620104008			I620104008	10.000
	10	7.5	4.5 - 6.5		2.34	V620104010	1.000	8.000	I620104010	8.000
	12		6.5 - 8.5		2.65	V620104012			I620104012	
4.8	08		2 - 4		3.60	V620104808			I620104808	7.000
	10	9	4 - 6		3.80	V620104810	500	6.000	I620104810	6.000
	12		6 - 8		4.05	V620104812			I620104812	

# SARIV INOX A2-INOX A2-TXL

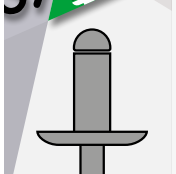
INOX A2  
INOX A2  
INOX A2  
EDELSTAHL A2  
НЕРЖ.СТАЛЬ A2

INOX A2  
INOX A2  
INOX A2  
EDELSTAHL A2  
НЕРЖ.СТАЛЬ A2



EXTRA-LARGE HEAD  
TESTA EXTRA-LARGA  
TÊTE EXTRA-LARGE  
EXTRA-GROSSKOPF  
ЭКСТРА УВЕЛИЧЕННЫЙ БОРТИК

Ø	Ø mm	N	N
4.8	4.9 - 5.0	5.800	4.700

D1 mm	L mm	D2 mm	min-max mm	€/1000	1.000 Kg.	SARIV box Cod.	Pcs x SARIV box	Pcs Outer box	Industrial box Cod.	Pz x I-box
4.8	10		4 - 6		5.80	V620304810	500	4.000	I620304810	
	12		5.5 - 8		6.30	V620304812			I620304812	4.000
4.8	14	16	7.5 - 10		7.00	V620304814			I620304814	
	16		9.5 - 12		7.20	V620304816	250	2.000	I620304816	3.500
	20		13.5 - 16		8.00	V620304820			I620304820	

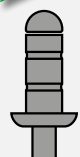

# SARIV ALU-ACC-M'GRIP

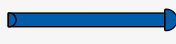
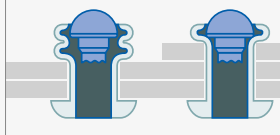
ALUMINIUM AL MG 2,5  
ALLUMINIO AL MG 2,5  
ALUMINIUM AL MG 2,5  
ALUMINIUM AL MG 2,5  
АЛЮМИНИЙ AL MG 2,5



ZINC PLATED STEEL  
ACCIAIO ZINCATO  
ACIER ZINGUE  
VERZINKTER STAHL  
ОЦИНКОВАННАЯ СТАЛЬ

MULTIGRIP TYPE  
RIVETTI MULTIGRIP  
RIVET MULTI-SERRAGE  
MEHRBEREICH  
МНОГОЗАЖИМНАЯ

Ø	Ø mm	N	N
3.2	3.3 - 3.4	900	650
4.0	4.1 - 4.2	1.550	950
4.8	4.9 - 5.0	2.200	1.700

D1 mm	L mm	D2 mm	min-max mm	€/1000	1.000 Kg.	SARIV box Cod.	Pcs x SARIV box	Pcs Outer box	Industrial box Cod.	Pz x I-box
	<b>08</b>		1 - 5.5		0.99	<b>V011003208</b>			<b>I011003208</b>	15.000
<b>3.2</b>	<b>9.5</b>	6.5	3 - 6.5		1.04	<b>V011003209</b>	1.000	18.000	<b>I011003209</b>	12.000
	<b>11.5</b>		4.5 - 8		1.09	<b>V011003211</b>			<b>I011003211</b>	
<b>4.0</b>	<b>10</b>		1.5 - 6.5		1.62	<b>V011004010</b>	1.000	12.000	<b>I011004010</b>	10.000
	<b>13</b>	8	4.5 - 9.5		1.79	<b>V011004013</b>			<b>I011004013</b>	8.000
	<b>17</b>		8 - 13		2.02	<b>V011004017</b>	500	9.000	<b>I011004017</b>	6.000
<b>4.8</b>	<b>11</b>		1 - 6.5		2.55	<b>V011004811</b>		9.000	<b>I011004811</b>	6.000
	<b>15</b>	9.5	5 - 10.5		2.89	<b>V011004815</b>	500		<b>I011004815</b>	5.000
	<b>17</b>		6 - 12.5		3.03	<b>V011004817</b>		6.000	<b>I011004817</b>	
	<b>25</b>		12.5 - 20		3.69	<b>V011004825</b>			<b>I011004825</b>	4.000
<b>4.8</b>	<b>10</b>		1 - 6		2.88	<b>V011304810</b>	500	6.000	<b>I011304810</b>	4.000
	<b>16</b>	TXL 16	6 - 12		3.44	<b>V011304816</b>	250	4.500	<b>I011304816</b>	3.000
	<b>25</b>		13 - 20		4.25	<b>V011304825</b>		3.000	<b>I011304825</b>	2.500

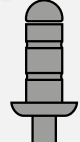
# SARIV ACC-ACC-M'GRIP

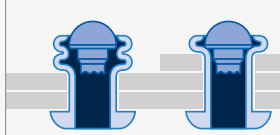
ZINC PLATED STEEL  
ACCIAIO ZINCATO  
ACIER ZINGUE  
VERZINKTER STAHL  
ОЦИНКОВАННАЯ СТАЛЬ





ZINC PLATED STEEL  
ACCIAIO ZINCATO  
ACIER ZINGUE  
VERZINKTER STAHL  
ОЦИНКОВАННАЯ СТАЛЬ

MULTIGRIP TYPE  
RIVETTI MULTIGRIP  
RIVET MULTI-SERRAGE  
MEHRBEREICH  
МНОГОЗАЖИМНАЯ

Ø	Ø mm	N	N
3.2	3.3 - 3.4	1.400	1.000
4.0	4.1 - 4.2	2.300	1.650
4.8	4.9 - 5.0	3.500	2.600

D1 mm	L mm	D2 mm	min-max mm	€/1000	1.000 Kg.	SARIV box Cod.	Pcs x SARIV box	Pcs Outer box	Industrial box Cod.	Pz x I-box
<b>3.2</b>	<b>10</b>	6.5	1.5 - 4		1.77	<b>V111003210</b>	1.000	8.000	<b>I111003210</b>	13.000
<b>4.0</b>	<b>11</b>	8.0	1.5 - 7		2.74	<b>V111004011</b>	1.000	8.000	<b>I111004011</b>	8.000
<b>4.8</b>	<b>11</b>	9.5	1.5 - 5		4.12	<b>V111004811</b>	500	6.000	<b>I111004811</b>	6.000
	<b>14</b>		4 - 8		4.69	<b>V111004814</b>		4.000	<b>I111004814</b>	5.000

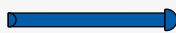
# SARIV ALU-ACC-FIORE

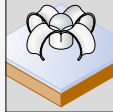
ALUMINIUM AL MG 3,5  
ALLUMINIO AL MG 3,5  
ALUMINIUM AL MG 3,5  
ALUMINIUM AL MG 3,5  
АЛЮМИНИЙ АL MG 3,5

ZINC PLATED STEEL  
ACCIAIO ZINCATO  
ACIER ZINGUE  
VERZINKTER STAHL  
ОЦИНКОВАННАЯ СТАЛЬ

PEEL TYPE  
RIVETTO A FIORE  
RIVET ÉCLATÉ  
SPREIZNIET  
ЛЕПЕСТКОВАЯ

Ø	Ø mm	N	N
4.0	4.1 - 4.2	1.500	1.250
4.8	4.9 - 5.0	1.900	2.000

D1 mm	L mm	D2 mm	min-max mm	€/1000	1.000 Kg.	SARIV box Cod.	Pcs x SARIV box	Pcs Outer box	Industrial box Cod.	Pz x I-box
4.0	08	8	1 - 3		1.80	V014004008	1.000	12.000	I014004008	10.000
	12		3 - 6		1.90	V014004012			I014004012	8.000
	16		5.5 - 10		2.12	V014004016	500	9.000	I014004016	7.000
	20		9.5 - 14		2.34	V014004020		I014004020	6.000	
	24		13.5 - 18		2.60	V014004024		6.000	I014004024	5.000
4.8	10	9.5	2 - 4		2.70	V014004810		9.000	I014004810	6.000
	12		3 - 7		2.77	V014004812			I014004812	
	14		4 - 8		3.05	V014004814	500		I014004814	5.000
	16		4.5 - 10		3.15	V014004816		6.000	I014004816	
	20		9.5 - 14		3.45	V014004820			I014004820	4.000
	24		13.5 - 18		3.80	V014004824			I014004824	3.500
	30		17.5 - 22		4.26	V014004830		4.500	I014004830	3.000
	35		21.5 - 27		4.74	V014004835	250	3.000	I014004835	
	40		26.5 - 32		5.10	V014004840			I014004840	2.500
	45		31.5 - 37		5.60	V014004845	200	2.400	I014004845	2.000
50	36.5 - 42		6.05	V014004850	150	1.800	I014004850	1.500		

# SARIV ALU-ACC-ERM

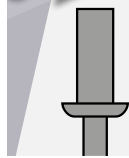

ALUMINIUM AL MG 5  
 ALLUMINIO AL MG 5  
 ALUMINIUM AL MG 5  
 ALUMINIUM AL MG 5  
 АЛЮМИНИЙ АL МG 5



POLISHED STEEL  
 ACCIAIO LUCIDATO  
 ACIER ASTIQUE  
 POLIERTER STAHL  
 ПОЛИРОВАННАЯ СТАЛЬ



SEALED TYPE  
 RIVETTO ERMETICO  
 RIVET ÉTANCHE  
 GESCHLOSSEN  
 ЗАКРЫТАЯ

Ø	Ø mm	N	N
3.2	3.3 - 3.4	1.150	900
4.0	4.1 - 4.2	2.200	1.500
4.8	4.9 - 5.0	2.750	2.200

D1 mm	L mm	D2 mm	min-max mm	€/1000	1.000 Kg.	SARIV box Cod.	Pcs x SARIV box	Pcs Outer box	Industrial box Cod.	Pz x I-box		
	08		1.5 - 3		0.96	V017003208		18.000	I017003208	15.000		
	09.5		3 - 5.5		0.99	V017003209			I017003209	13.000		
3.2	10.7	6.5	4.5 - 6		1.02	V017003210	1.000		I017003210			
	11.5		6 - 7.5		1.12	V017003211		12.000	I017003211	12.000		
	12.7		7 - 9		1.15	V017003212			I017003212			
4.0	08		1 - 3		1.51	V017004008			I017004008	10.000		
	10		3 - 5		1.56	V017004010	1.000	12.000	I017004010	8.000		
	11.5	8	5 - 6.5		1.67	V017004011			I017004011			
	13		6.5 - 8.5		1.70	V017004013			I017004013	7.000		
	14.5		8 - 10.5		1.85	V017004014			500	9.000	I017004014	
4.8	08			2 - 4		2.15	V017004808	1.000	12.000	I017004808	7.000	
	09.5		3 - 5		2.33	V017004809	9.000			I017004809		
	11		5 - 7		2.48	V017004811				I017004811	6.000	
	12.5	9.5	6 - 8		2.67	V017004812	500				I017004812	
	15.5		8.5 - 11		2.82	V017004815				6.000	I017004815	5.000
	18		10.5 - 13		3.02	V017004818					I017004818	4.000
22	13 - 16			3.30	V017004822			I017004822				

# SARIV INOX A2-INOX-ERM



INOX A2  
INOX A2  
INOX A2  
EDELSTAHL A2  
НЕРЖ.СТАЛЬ А2

INOX  
INOX  
INOX  
EDELSTAHL  
НЕРЖ.СТАЛЬ

SEALED TYPE  
RIVETTO ERMETICO  
RIVET ÉTANCHE  
GESCHLOSSEN  
ЗАКРЫТАЯ

Ø	Ø mm	N	N
3.2	3.3 - 3.4	2.200	2.000
4.0	4.1 - 4.2	3.400	3.300
4.8	4.9 - 5.0	5.200	4.200

D1 mm	L mm	D2 mm	min-max mm	€/1000	1.000 Kg.	SARIV box Cod.	Pcs x SARIV box	Pcs Outer box	Industrial box Cod.	Pz x I-box
3.2	08		1 - 3		1.38	V527003208		12.000	I527003208	15.000
	09.5	6.5	3 - 5		1.41	V527003209	1.000		I527003209	14.000
	12		5 - 6.5		1.44	V527003212		8.000	I527003212	12.000
4.0	08		1 - 3		2.15	V527004008		8.000	I527004008	10.000
	09.5	8	3 - 5		2.25	V527004009	1.000		I527004009	
	12		5 - 6.5		2.45	V527004012		6.000	I527004012	8.000
4.8	16		6.5 - 10.5		2.84	V527004016	500		I527004016	7.000
	09.5	9.5	3 - 5		3.30	V527004809	500	6.000	I527004809	7.000
	12		5 - 6.5		3.60	V527004812		4.000	I527004812	6.000

# SARIV ALU-ALU-3ALI



ALUMINIUM AL MG 2,5  
ALLUMINIO AL MG 2,5  
ALUMINIUM AL MG 2,5  
ALUMINIUM AL MG 2,5  
АЛЮМИНИЙ AL MG 2,5



ALUMINIUM AL MG 5  
ALLUMINIO AL MG 5  
ALUMINIUM AL MG 5  
ALUMINIUM AL MG 5  
АЛЮМИНИЙ AL MG 5

3 WINGS  
3 ALI  
3 AILES  
3 FLÜGEL  
РАСПОРНАЯ

Ø	Ø mm	N	N
4.0	4.1 - 4.2	800	700
4.8	4.9 - 5.0	1.600	1.100

D1 mm	L mm	D2 mm	min-max mm	€/1000	1.000 Kg.	SARIV box Cod.	Pcs x SARIV box	Pcs Outer box	Industrial box Cod.	Pz x I-box
4.0	16		1 - 5		1.12	V036004016		9.000	I036004016	7.000
	20	8	3 - 8		1.28	V036004020	500	6.000	I036004020	5.000
	25		5 - 11		1.45	V036004025			I036004025	
4.8	16		1 - 3		1.65	V036004816			I036004816	5.000
	20	9.5	3 - 8		1.84	V036004820	500	6.000	I036004820	
	25		5 - 11		2.07	V036004825			I036004825	4.000

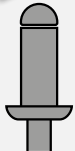
# SARIV ALU-ACC-TT-RAL 9005

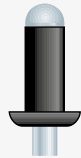
**ALUMINIUM AL MG 3,5**  
**ALLUMINIO AL MG 3,5**  
**ALUMINIUM AL MG 3,5**  
**ALUMINIUM AL MG 3,5**  
**АЛЮМИНИЙ AL MG 3,5**

**ZINC PLATED STEEL**  
**ACCIAIO ZINCATO**  
**ACIER ZINGUÉ**  
**VERZINKTER STAHL**  
**ОЦИНКОВАННАЯ СТАЛЬ**





**RAL 9005**  
**BLACK**  
**NERO**  
**NOIR**  
**SCHWARZ**  
**ЧЕРНЫЙ**

**DOME HEAD**  
**TESTA TONDA**  
**TÊTE PLATE**  
**FLACHRUNDKOPF**  
**СТАНДАРТНЫЙ БОРТИК**

Ø	Ø mm	N	N
3.0	3.1 - 3.2	950	600
3.2	3.3 - 3.4	1.000	750
4.0	4.1 - 4.2	1.750	1.200
4.0	4.1 - 4.2	2.600	1.850

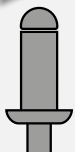
D1 mm	L mm	D2 mm	min-max mm	€/1000	1.000 Kg.	SARIV box Cod.	Pcs x SARIV box	Pcs Outer box	Industrial box Cod.	Pz x I-box
3.0	06		1 - 3		0.96	V90053006			I90053006	16.000
	08	6.5	3 - 5		0.98	V90053008	1.000	18.000	I90053008	15.000
	10		5 - 7		1.05	V90053010			I90053010	13.000
	12		7 - 9		1.08	V90053012			I90053012	12.000
3.2	06		1 - 3		1.08	V90053206			I90053206	16.000
	08	6.5	3 - 5		1.16	V90053208	1.000	18.000	I90053208	15.000
	10		5 - 7		1.23	V90053210			I90053210	13.000
	12		7 - 9		1.28	V90053212			I90053212	12.000
4.0	07		2 - 3.5		1.63	V90054007			I90054007	
	08		3 - 4.5		1.65	V90054008			I90054008	10.000
	10	8	5 - 6.5		1.79	V90054010	1.000	12.000	I90054010	
	12		7 - 8.5		1.89	V90054012			I90054012	8.000
	14		8 - 10.5		2.09	V90054014			I90054014	
4.8	16		10 - 12.5		2.12	V90054016	500	9.000	I90054016	7.000
	08		2.5 - 4		2.36	V90054808	1.000	12.000	I90054808	7.000
	10	9.5	4.5 - 6		2.54	V90054810		9.000	I90054810	
	12		6.5 - 8		2.68	V90054812	500		I90054812	6.000
	16		9.5 - 12		3.06	V90054816		6.000	I90054816	5.000

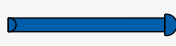
# SARIV ALU-ACC-TT-RAL 9010

**ALUMINIUM AL MG 3,5**  
**ALLUMINIO AL MG 3,5**  
**ALUMINIUM AL MG 3,5**  
**ALUMINIUM AL MG 3,5**  
**АЛЮМИНИЙ AL MG 3,5**

**ZINC PLATED STEEL**  
**ACCIAIO ZINCATO**  
**ACIER ZINGUÉ**  
**VERZINKTER STAHL**  
**ОЦИНКОВАННАЯ СТАЛЬ**

**RAL 9010**  
**WHITE**  
**BIANCO**  
**BLANC**  
**WEIß**  
**БЕЛЫЙ**

**DOME HEAD**  
**TESTA TONDA**  
**TÊTE PLATE**  
**FLACHRUNDKOPF**  
**СТАНДАРТНЫЙ БОРТИК**

Ø	Ø mm	N	N
3.0	3.1 - 3.2	950	600
3.2	3.3 - 3.4	1.000	750
4.0	4.1 - 4.2	1.750	1.200
4.0	4.1 - 4.2	2.600	1.850

D1 mm	L mm	D2 mm	min-max mm	€/1000	1.000 Kg.	SARIV box Cod.	Pcs x SARIV box	Pcs Outer box	Industrial box Cod.	Pz x I-box
3.0	06		1 - 3		0.96	V90103006			I90103006	16.000
	08	6.5	3 - 5		0.98	V90103008	1.000	18.000	I90103008	15.000
	10		5 - 7		1.05	V90103010			I90103010	13.000
	12		7 - 9		1.08	V90103012			I90103012	12.000
3.2	06		1 - 3		1.08	V90103206			I90103206	16.000
	08	6.5	3 - 5		1.16	V90103208	1.000	18.000	I90103208	15.000
	10		5 - 7		1.23	V90103210			I90103210	13.000
	12		7 - 9		1.28	V90103212			I90103212	12.000
4.0	06		2 - 3.5		1.63	V90104006			I90104006	
	08	8	3 - 4.5		1.65	V90104008	1.000	12.000	I90104008	10.000
	10		5 - 6.5		1.79	V90104010			I90104010	

	12		7 - 8.5	1.89	V90104012	1.000	12.000	I90104012	8.000
4.0	14	8	8 - 10.5	2.09	V90104014			I90104014	
	16		10 - 12.5	2.12	V90104016	500	9.000	I90104016	7.000
	08		2.5 - 4	2.36	V90104808		12.000	I90104808	7.000
4.8	10	9.5	4.5 - 6	2.54	V90104810	1.000	9.000	I90104810	
	12		6.5 - 8	2.68	V90104812			I90104812	6.000
	16		9.5 - 12	3.06	V90104816	500	6.000	I90104816	5.000

# SARIV ALU-ACC-TT-RAL 8017

ALUMINIUM AL MG 3,5  
ALLUMINIO AL MG 3,5  
ALUMINIUM AL MG 3,5  
ALUMINIUM AL MG 3,5  
АЛЮМИНИЙ AL MG 3,5

ZINC PLATED STEEL  
ACCIAIO ZINCATO  
ACIER ZINGUE  
VERZINKTER STAHL  
ОЦИНКОВАННАЯ СТАЛЬ

RAL 8017  
BROWN  
MARRONE  
MARRON  
BRAUN  
КОРИЧНЕВЫЙ

DOME HEAD  
TESTA TONDA  
TÊTE PLATE  
FLACHRUNDKOPF  
СТАНДАРТНЫЙ БОРТИК

Ø	Ø mm	N	N
3.0	3.1 - 3.2	950	600
3.2	3.3 - 3.4	1.000	750
3.4	3.5 - 3.6	1.250	900
4.0	4.1 - 4.2	1.750	1.200
4.8	4.9 - 5.0	2.600	1.850

D1 mm	L mm	D2 mm	min-max mm	€/1000	1.000 Kg.	SARIV box Cod.	Pcs x SARIV box	Pcs Outer box	Industrial box Cod.	Pz x I-box
	06		1 - 3		0.96	V80173006			I80173006	16.000
3.0	08	6.5	3 - 5		0.98	V80173008	1.000	18.000	I80173008	15.000
	10		5 - 7		1.05	V80173010			I80173010	13.000
	12		7 - 9		1.08	V80173012			I80173012	12.000
	07		2 - 4		1.12	V80173207			I80173207	16.000
3.2	09	6.5	4 - 6		1.20	V80173209	1.000	18.000	I80173209	15.000
	10		5 - 7		1.23	V80173210			I80173210	13.000
	12		7 - 9		1.28	V80173212			I80173212	12.000
	07		2 - 4		1.34	V80173407			I80173407	12.000
3.4	09	7	4 - 6		1.37	V80173409	1.000	12.000	I80173409	11.000
	11		6 - 8		1.52	V80173411			I80173411	
	07		2 - 3.5		1.63	V80174007			I80174007	
	08		3 - 4.5		1.65	V80174008			I80174008	10.000
4.0	09	8	4 - 5.5		1.76	V80174009	1.000	12.000	I80174009	
	10		5 - 6.5		1.79	V80174010			I80174010	
	12		7 - 8.5		1.89	V80174012			I80174012	8.000
	16		10 - 12.5		2.12	V80174016	500	9.000	I80174016	7.000
	08		2.5 - 4		2.36	V80174808	1.000	12.000	I80174808	7.000
4.8	10	9.5	4.5 - 6		2.54	V80174810	500	9.000	I80174810	
	12		6.5 - 8		2.68	V80174812			I80174812	6.000

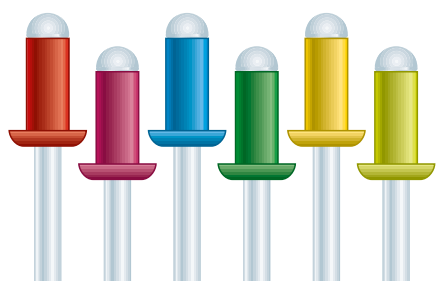

\*RIVETS OF ALL RAL OR SAMPLE COLOURS CAN BE PRODUCED. PRICES AND MINIMUM QUANTITY TO BE AGREED.

\*SONO FORNIBILI RIVETTI IN TUTTI I TIPI DI RAL O IN COLORI A CAMPIONE. PREZZI E QUANTITATIVI MINIMI DA CONCORDARE.

\*LES RIVETS PEUVENT ÊTRE LIVRÉS DANS TOUTES LES COULEURS RAL OU SUR ÉCHANTILLON. PRIX ET QUANTITÉ MINIMUM : NOUS CONSULTER.

\*LIEFERBAR SIND ALLE NIETEN NACH RAL FARBEN ODER KUNDENMUSTER. PREISE UND MINDESTMENGE AUF ANFRAGE.

\*МОГУТ ПОСТАВЛЯТЬСЯ ЗАКЛЕПКИ ВСЕХ ЦВЕТОВ RAL ИЛИ ЦВЕТОВ ПО ОБРАЗЦУ. ЦЕНЫ И МИНИМАЛЬНАЯ ПАРТИЯ ПО ДОГОВОРЕННОСТИ.

**SELF SERVICE PACK**  
**CONFEZIONI SELF SERVICE**  
**CONFECTIONS SELF SERVICE**  
**SELF-SERVICE PACKUNGEN**  
**МИНИ УПАКОВКА (БЛИСТЕР)**

On request all types of rivets (listed in this catalog) can be supplied in a 100- piece self service pack.

A richiesta possono essere forniti tutti i tipi di rivetti presenti in questo catalogo in confezioni self service da 100 pezzi.

Nous pouvons fournir, sur demande, tous les types de rivets présents dans ce catalogue sous confections self service de 100 pièces.

Auf Anfrage können alle in diesem Katalog aufgeführten Nietarten in Packungen zu 100 Stück geliefert werden.

По запросу могут поставляться все виды представленных в данном каталоге заклепок в упаковках по 100 штук для вывешивания.



## SELF SERVICE ALU-ACC-TT

ALUMINIUM AL MG 3,5  
 ALLUMINIO AL MG 3,5  
 ALUMINIUM AL MG 3,5  
 ALUMINIUM AL MG 3,5  
 АЛЮМИНИЙ AL MG 3,5

ZINC PLATED STEEL  
 ACCIAIO ZINCATO  
 ACIER ZINGUE  
 VERZINKTER STAHL  
 ОЦИНКОВАННАЯ СТАЛЬ

DOME HEAD  
 TESTA TONDA  
 TÊTE PLATE  
 FLACHRUNDKOPF  
 СТАНДАРТНЫЙ БОРТИК

Ø	Ø mm	N	N
3.0	3.1 - 3.2	950	600
3.2	3.3 - 3.4	1.000	750
3.4	3.5 - 3.6	1.250	900
4.0	4.1 - 4.2	1.750	1.200
4.8	4.9 - 5.0	2.600	1.850

D1 mm	L mm	D2 mm	min-max mm	€/1000	Kg.	SARIV SELF-SERVICE Cod.	Pcs x SELF-SERVICE	Pcs Outer box
3.0	07	6.5	2 - 4	1.06	1.06	010033007	100	5.000
	09		4 - 6			010033009		
	11		6 - 8			010033011		
3.2	07	6.5	2 - 4	1.08	1.08	010033207	100	5.000
	09		4 - 6			010033209		
	11		6 - 8			010033211		
3.4	07	7	2 - 4	1.40	1.40	010033407	100	5.000
	09		4 - 6			010033409		
	11		6 - 8			010033411		
	12		7 - 9			010033412		
4.0	14	8	9 - 11	1.70	1.70	010033414	100	5.000
	07		2 - 3.5			010034007		
	09		4 - 5.5			010034009		
	11		6 - 7.5			010034011		
4.8	12	9.5	7 - 8.5	1.85	1.85	010034012	100	3.000
	14		8 - 10.5			010034014		
	16		10 - 12.5			010034016		
	09		2 - 3.5			010034809		
4.8	11	9.5	3 - 5.5	2.65	2.65	010034811	100	3.000
	12		5 - 7.5			010034812		
	14		7 - 8.5			010034814		
	16		8 - 10.5			010034816		
	20		10 - 12.5	3.30	3.30	010034820		

# SARIV SELF SERVICE ALU-ACC-TXL

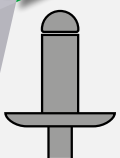
ALUMINIUM AL MG 3,5  
ALLUMINIO AL MG 3,5  
ALUMINIUM AL MG 3,5  
ALUMINIUM AL MG 3,5  
АЛЮМИНИЙ AL MG 3,5

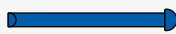

ZINC PLATED STEEL  
ACCIAIO ZINCATO  
ACIER ZINGUE  
VERZINKTER STAHL  
ОЦИНКОВАННАЯ СТАЛЬ

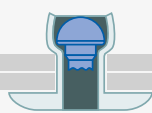

EXTRA-LARGE HEAD  
TESTA EXTRA-LARGA  
TÊTE EXTRA-LARGE  
EXTRA-GROSSKOPF  
ЭКСТРА УВЕЛИЧЕННЫЙ БОРТИК

Ø	Ø mm	N	N
4.8	4.9 - 5.0	2.600	1.850

D1 mm	L mm	D2 mm	min-max mm	€/1000	1.000 Kg.	SARIV SELF-SERVICE Cod.	Pcs x SELF-SERVICE	Pcs Outer box		
	12		5.5 - 8		3.36	010334812				
	14		7.5 - 10		3.59	010334814				
4.8	16	16	9.5 - 12		3.70	010334816	50	1.500		
	18		11.5 - 14		3.76	010334818				
	20		13.5 - 16		4.02	010334820				

# SARIV SELF SERVICE CU-ACC-TT

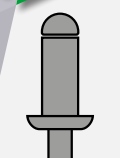
COPPER (CU)  
RAME (CU)  
CUIVRE (CU)  
KUPFER (CU)  
МЕДЬ (CU)



ZINC PLATED STEEL  
ACCIAIO ZINCATO  
ACIER ZINGUE  
VERZINKTER STAHL  
ОЦИНКОВАННАЯ СТАЛЬ





DOME HEAD  
TESTA TONDA  
TÊTE PLATE  
FLACHRUNDKOPF  
СТАНДАРТНЫЙ БОРТИК

Ø	Ø mm	N	N
3.0	3.1 - 3.2	1.050	7500
3.2	3.3 - 3.4	1.200	850
3.4	3.5 - 3.6	1.350	1.000
4.0	4.1 - 4.2	2.000	1.400

D1 mm	L mm	D2 mm	min-max mm	€/1000	1.000 Kg.	SARIV SELF-SERVICE Cod.	Pcs x SELF-SERVICE	Pcs Outer box		
	07		2 - 4		1.36	210033007				
3.0	09	6.5	4 - 6		1.48	210033009	100	5.000		
	11		6 - 8		1.61	210033011				
	07		2 - 4		1.60	210033207				
3.2	09	6.5	4 - 6		1.75	210033209	100	5.000		
	11		6 - 8		1.86	210033211				
	07		1 - 3		1.75	210033407				
3.4	09	7	4 - 6		1.90	210033409	100	5.000		
	11		6 - 8		2.10	210033411				
	12		7 - 9		2.20	210033412				
	07		2 - 3.5		2.50	210034007				
4.0	09	8	3 - 5		2.60	210034009	100	5.000		
	11		5 - 7		2.84	210034011				
	12		5.5 - 8.5		2.90	210034012		3.000		

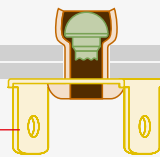

## SARIV CU-ACC-EL

**COPPER**  
 RAME  
 CUIVRE  
 KUPFER  
 МЕДЬ



**COPPER-PLATED STEEL**  
 ACCIAIO RAMATO  
 ACIER CUIVRE  
 STAHL KUPFER ÜBERZOGEN  
 ОМЕДНЕННАЯ СТАЛЬ

**BRASS**  
 FASTON IN OTTONE  
 LAITON  
 MESSING  
 ЗАЗЕМЛЕНИЕ ИЗ ЛАТУНИ

Ø	Ø mm	N	N
4.0	5.2	2.000	1.500

D1 mm	L mm	D2 mm	min-max mm	€/1000	1.000 Kg.	SARIV box Cod.	Pcs x SARIV box	Pcs Outer box	Industrial box Cod.	Pz x I-box
4.0	09	8	1 - 2		4.20	<b>VM211024009</b>	250	2.000	<b>IM211024009</b>	3.000

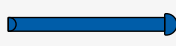
## SARIV ALU-ACC-EL

**ALUMINIUM AL MG 3,5**  
 ALLUMINIO AL MG 3,5  
 ALUMINIUM AL MG 3,5  
 ALUMINIUM AL MG 3,5  
 АЛЮМИНИЙ AL MG 3,5





**ZINC PLATED STEEL**  
 ACCIAIO ZINCATO  
 ACIER ZINGUÉ  
 VERZINKTER STAHL  
 ОЦИНКОВАННАЯ СТАЛЬ

**DOME HEAD**  
 TESTA TONDA  
 TÊTE PLATE  
 FLACHRUNDKOPF  
 СТАНДАРТНЫЙ БОРТИК

Ø	Ø mm	N	N
4.0	4.1 - 4.2	1.550	950

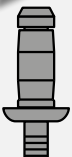
D1 mm	L mm	D2 mm	min-max mm	€/1000	1.000 Kg.	SARIV box Cod.	Pcs x SARIV box	Pcs Outer box	Industrial box Cod.	Pz x I-box
4.0	10	8	1.2 - 6		1.65	<b>VM011004010</b>	1.000	12.000	<b>IM011004010</b>	

# SARIV SARIBULB ACC-TT

ZINC PLATED STEEL  
ACCIAIO ZINCATO  
ACIER ZINGUE  
VERZINKTER STAHL  
ОЦИНКОВАННАЯ СТАЛЬ





ZINC PLATED STEEL  
ACCIAIO ZINCATO  
ACIER ZINGUE  
VERZINKTER STAHL  
ОЦИНКОВАННАЯ СТАЛЬ

DOME HEAD  
TESTA TONDA  
TÊTE PLATE  
FLACHRUNDKOPF  
СТАНДАРТНЫЙ БОРТИК

Ø	Ø mm	N	N
3.2	3.3 - 3.4	1.200	1.200 - 2.200
4.0	4.1 - 4.2	2.100	1.500 - 3.250
4.8	4.9 - 5.1	3.800	2.800 - 3.600
6.4	6.6 - 7.0	7.000	6.600 - 8.500

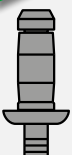
D1 mm	L mm	D2 mm	min-max mm	€/1000	1.000 Kg.	SARIV box Cod.	Pcs x SARIV box	Pcs Outer box	Industrial box Cod.	Pz x I-box
	7		1 - 3		1.56	VHB1103207		12.000	IHB1103207	15.000
3.2	9	6.5	3 - 5		1.71	VHB1103209	1.000		IHB1103209	
	11		5 - 7		1.84	VHB1103211		8.000	IHB1103211	13.000
	7		1 - 3		2.53	VHB1104007			IHB1104007	10.000
4.0	9	8	3 - 5		2.71	VHB1104009	1.000	8.000	IHB1104009	
	12		5 - 7		2.89	VHB1104012			IHB1104012	8.000
	9		1.5 - 3.5		3.67	VHB1104809		6.000	IHB1104809	6.000
4.8	12	9.5	3.5 - 5.5		4.07	VHB1104812	500		IHB1104812	
	15		5.5 - 7.5		4.67	VHB1104815		4.000	IHB1104815	5.000
6.4	12	13	2.0 - 6.0		8.77	VHB1106412	250	3.000	IHB1106412	3.000
	15		5.0 - 9.0		8.47	VHB1106415			IHB1106415	2.500

# SARIV SARIBULB INOX-TT

INOX  
INOX  
INOX  
EDELSTAHL  
НЕРЖ.СТАЛЬ





INOX  
INOX  
INOX  
EDELSTAHL  
НЕРЖ.СТАЛЬ

DOME HEAD  
TESTA TONDA  
TÊTE PLATE  
FLACHRUNDKOPF  
СТАНДАРТНЫЙ БОРТИК

Ø	Ø mm	N	N
3.0	3.3 - 3.4	2.100	1.700 - 3.700
4.0	4.1 - 4.2	3.000	3.100 - 5.400
4.8	4.9 - 5.1	5.400	5.500 - 9.000
6.4	6.6 - 7.0	8.500	9.000 - 14.000

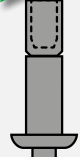
D1 mm	L mm	D2 mm	min-max mm	€/1000	1.000 Kg.	SARIV box Cod.	Pcs x SARIV box	Pcs Outer box	Industrial box Cod.	Pz x I-box
	7		1 - 3		1.55	VHB6203207		12.000	IHB6203207	15.000
3.2	9	6.5	3 - 5		1.70	VHB6203209	1.000		IHB6203209	
	11		5 - 7		1.85	VHB6203211		8.000	IHB6203211	13.000
	7		1 - 3		2.81	VHB6204007			IHB6204007	10.000
4.0	9	8	3 - 5		2.93	VHB6204009	1.000	8.000	IHB6204009	
	12		5 - 7		3.00	VHB6204012			IHB6204012	8.000
	9		1.5 - 3.5		3.67	VHB6204809		6.000	IHB6204809	6.000
4.8	12	9.5	3.5 - 6		4.07	VHB6204812	500		IHB6204812	
	15		5.5 - 7.5		4.67	VHB6204815		4.000	IHB6204815	5.000
6.4	12	13	2.0 - 6.0		8.80	VHB6206412	250	3.000	IHB6206412	3.000
	15		5.0 - 9.0		9.00	VHB6206415			IHB6206415	2.500

# SARIV SARIBOLT ACC-TT

ZINC PLATED STEEL  
ACCIAIO ZINCATO  
ACIER ZINGUÉ  
VERZINKTER STAHL  
ОЦИНКОВАННАЯ СТАЛЬ





ZINC PLATED STEEL  
ACCIAIO ZINCATO  
ACIER ZINGUÉ  
VERZINKTER STAHL  
ОЦИНКОВАННАЯ СТАЛЬ

DOMED HEAD  
TESTA TONDA  
TÊTE PLATE  
FLACHRUNDKOPF  
СТАНДАРТНЫЙ БОРТИК

Ø	Ø mm	N	N
4.8	4.9 - 5.1	3.800	5.200
6.4	6.6 - 7.0	6.500	8.800

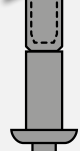
D1 mm	L mm	D2 mm	min-max mm	€/1000	1.000 Kg.	SARIV box Cod.	Pcs x SARIV box	Pcs Outer box	Industrial box Cod.	Pz x I-box
	10	10	1.6 - 6.8		3.92	VHM1104810	500	4.000	IHM1104810	5.000
4.8	14		1.6 - 11.1		4.52	VHM1104814			IHM1104814	4.000
	14	13	2.0 - 9.5		8.37	VHM1106414	250	2.000	IHM1106414	2.500
6.4	19		2.0 - 15.9		9.87	VHM1106419			IHM1106419	2.000

# SARIV SARIBOLT ACC-TS

ZINC PLATED STEEL  
ACCIAIO ZINCATO  
ACIER ZINGUÉ  
VERZINKTER STAHL  
ОЦИНКОВАННАЯ СТАЛЬ





ZINC PLATED STEEL  
ACCIAIO ZINCATO  
ACIER ZINGUÉ  
VERZINKTER STAHL  
ОЦИНКОВАННАЯ СТАЛЬ

COUNTERSUNK HEAD (100°)  
TESTA SVASATA (100°)  
TÊTE FRAISÉE (100°)  
SENKKOPF (100°)  
ПОТАЙНОЙ БОРТИК (100°)

Ø	Ø mm	N	N
4.8	4.9 - 5.1	3.800	5.200
6.4	6.6 - 7.0	6.500	8.800

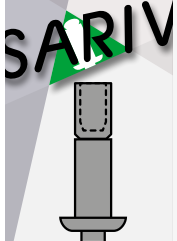
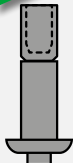
D1 mm	L mm	D2 mm	min-max mm	€/1000	1.000 Kg.	SARIV box Cod.	Pcs x SARIV box	Pcs Outer box	Industrial box Cod.	Pz x I-box
4.8	13	8.5	3.2 - 8.4		3.67	VHM1114813	500	4.000	IHM11104813	5.000
6.4	16	10	3.2 - 12.1		7.72	VHM1116416	250	2.000	IHM11106416	2.500

# SARIV SARIBOLT INOX A2-TT

INOX A2  
INOX A2  
INOX A2  
EDELSTAHL A2  
НЕРЖ.СТАЛЬ A2





INOX A2  
INOX A2  
INOX A2  
EDELSTAHL A2  
НЕРЖ.СТАЛЬ A2

DOVE HEAD  
TESTA TONDA  
TÊTE PLATE  
FLACHRUNDKOPF  
СТАНДАРТНЫЙ БОРТИК

Ø	Ø mm	N	N
4.8	4.9 - 5.1	4.300	5.400
6.4	6.6 - 7.0	7.000	9.600

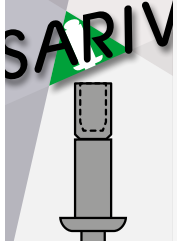
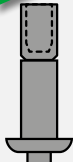
D1 mm	L mm	D2 mm	min-max mm	€/1000	1.000 Kg.	SARIV box Cod.	Pcs x SARIV box	Pcs Outer box	Industrial box Cod.	Pz x I-box
4.8	10	10	1.6 - 6.8		3.92	<b>VHM6204810</b>	500	4.000	<b>IHM6204810</b>	5.000
	14		1.6 - 11.1		4.52	<b>VHM6204814</b>			<b>IHM6204814</b>	4.000
6.4	14	13	2.0 - 9.5		8.37	<b>VHM6206414</b>	250	2.000	<b>IHM6206414</b>	2.500
	19		2.0 - 15.9		9.87	<b>VHM6206419</b>			<b>IHM6206419</b>	2.000

# SARIV SARIBOLT INOX A2-TS

INOX A2  
INOX A2  
INOX A2  
EDELSTAHL A2  
НЕРЖ.СТАЛЬ A2

INOX A2  
INOX A2  
INOX A2  
EDELSTAHL A2  
НЕРЖ.СТАЛЬ A2

COUNTERSUNK HEAD (100°)  
TESTA SVASATA (100°)  
TÊTE FRAISÉE (100°)  
SENKKOPF (100°)  
ПОТЯИНОЙ БОРТИК (100°)

Ø	Ø mm	N	N
6.4	6.6 - 7.0	7.000	9.600

D1 mm	L mm	D2 mm	min-max mm	€/1000	1.000 Kg.	SARIV box Cod.	Pcs x SARIV box	Pcs Outer box	Industrial box Cod.	Pz x I-box
6.4	16	10	3.2 - 12.1		7.72	<b>VHM6216416</b>	250	2.000	<b>IHM62106416</b>	5.000

# SARIV ULTRABOLT ACC-TT

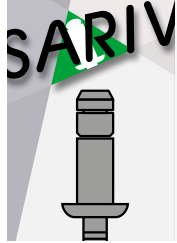

ZINC PLATED STEEL  
ACCIAIO ZINCATO  
ACIER ZINGUE  
VERZINKTER STAHL  
ОЦИНКОВАННАЯ СТАЛЬ



ZINC PLATED STEEL  
ACCIAIO ZINCATO  
ACIER ZINGUE  
VERZINKTER STAHL  
ОЦИНКОВАННАЯ СТАЛЬ

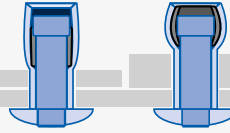

DOME HEAD  
TESTA TONDA  
TÊTE PLATE  
FLACHRUNDKOPF  
СТАНДАРТНЫЙ БОРТИК

Ø	Ø mm	N	N
6.4	6.6 - 7.0	7.000	10.500

D1 mm	L mm	D2 mm	min-max mm	€/1000	1.000 Kg.	SARIV box Cod.	Pcs x SARIV box	Pcs Outer box	Industrial box Cod.	Pz x I-box
	17.5		2 - 6		9.23	VHU1106417			IHU1106417	3.000
6.4	21.5	13	6 - 10		10.18	VHU1106421	250	2.000	IHU1106421	2.500
	29		2 - 10		11.70	VHU1106429			IHU1106429	

AVAILABLE FROM 2015  
DISPONIBILE DAL 2015  
DISPONIBLE À PARTIR DE 2015  
VERFÜGBAR AB 2015  
В НАЛИЧИИ С 2015 ГОДА

**PATENTED**



MATERIALS - MATERIALI - MATIÈRES - MATERIALIEN - МАТЕРИАЛЫ

<p><b>ALU</b></p> <p>ALUMINIUM ALLUMINIO ALUMINIUM ALUMINIUM АЛЮМИНИЙ</p>	<p><b>ACC</b></p> <p>ZINC PLATED STEEL ACCIAIO ZINCATO ACIER ZINGUE VERZINKTER STAHL ОЦИНКОВАННАЯ СТАЛЬ</p>	<p><b>INOX A2</b></p> <p>INOX A2 INOX A2 INOX A2 EDELSTAHL A2 НЕРЖ.СТАЛЬ A2</p>
---	---	---

TIPO - MODEL - MODÈLE - MODEL - ТИП ЗАКЛЕПКИ

<p><b>-C</b></p> <p>CYLINDRICAL BLIND RIVET NUTS INSERTI FILETTATI CILINDRICI ÉCROUS À SERTIR CYLINDRIQUES RUND BLINDNIETMUTTER ЦИЛИНДРИЧЕСКИЕ ГАЕЧНЫЕ ЗАКЛЕПКИ</p>	<p><b>-E</b></p> <p>HEXAGONAL BLIND RIVET NUTS INSERTI FILETTATI ESAGONALI ÉCROUS À SERTIR HEXAGONAUX BLINDNIETMUTTER, SCHAFT 6-KT. ШЕСТИГРАННЫЕ ГАЕЧНЫЕ ЗАКЛЕПКИ</p>	<p><b>-CE</b></p> <p>CLOSED CYLINDRICAL BLIND RIVET NUTS INSERTI CHIUSI FILETTATI CILINDRICI ÉCROUS À SERTIR CYLINDRIQUES ÉTANCHES GESCHLOSSEN BLINDNIETMUTTER, RUND SCHAFT ЗАКРЫТЫЕ ЦИЛИНДРИЧЕСКИЕ ГАЕЧНЫЕ ЗАКЛЕПКИ</p>	<p><b>-EE</b></p> <p>CLOSED HEXAGONAL BLIND RIVET NUTS INSERTI CHIUSI FILETTATI ESAGONALI ÉCROUS À SERTIR HEXAGONAUX ÉTANCHES GESCHLOSSEN BLINDNIETMUTTER, SCHAFT 6-KT. ЗАКРЫТЫЕ ШЕСТИГРАННЫЕ ГАЕЧНЫЕ ЗАКЛЕПКИ</p>
---	---	--	--

HEAD TYPE - TIPO DI TESTA - TYPE DE TÊTE - ART DER KOPF - ТИП БОРТИКА

<p><b>TC</b></p> <p>CYLINDRICAL HEAD TESTA CILINDRICA TÊTE CYLINDRIQUE ZYLINDRISCHER KOPF СТАНДАРТНЫЙ БОРТИК</p>	<p><b>TR</b></p> <p>REDUCED HEAD TESTA RIDOTTA TÊTE RÉDUITE REDUZIERTER KOPF УМЕНЬШЕННЫЙ БОРТИК</p>	<p><b>TS</b></p> <p>COUNTERSUNK HEAD TESTA SVASATA TÊTE FRAISÉE SENKKOPF ПОТАЙНОЙ БОРТИК</p>
--	---	--

BODY - CORPO - CORPS - KÖRPER - КОРПУС

<p><b>-L</b></p> <p>PLAIN BODY CORPO LISCIO FÛT LISSE GLATT SCHAFT ГЛАДКИЕ</p>	<p><b>-Z</b></p> <p>KNURLED BODY CORPO ZIGRINATO FÛT CRANTÉ GERÄNDEL SCHAFT С НАСЕЧКОЙ</p>
--	--



MATERIAL	HEAD TYPE - TIPO DI TESTA - TYPE DE TÊTE - ART DER KOPF - ТИП БОРТИКА			pag.
	<b>BLIND RIVETS NUTS</b>			
	HEAD TYPE - TIPO DI TESTA - TYPE DE TÊTE - ART DER KOPF - ТИП БОРТИКА			
ACC	CTC-Z			42
	CTC-L			42
		CTR-Z		43
		CTR-L		43
			CTS-Z	44
			CTS-L	44
		ETC		45
			ETR	45
	CETC-Z		46	
	EETC		46	
INOX A2	CTC-Z			47
ALU	CTC-L			47

WE CAN SUPPLY SPECIAL BLIND RIVET NUTS ACCORDING TO CUSTOMER'S REQUIREMENTS  
 È POSSIBILE FORNIRE INSERTI SPECIALI SECONDO SPECIFICHE DEL CLIENTE  
 IL EST POSSIBLE DE FOURNIR DES ÉCROUS SPECIALES SUR DEMANDE  
 WIR KÖNNEN SPEZIELLE BLINDNIETMUTTERN NACH KUNDENWUNSCH LIEFERN  
 ВОЗМОЖНА ПОСТАВКА СПЕЦИАЛЬНЫХ ГАЕЧНЫХ ЗАКЛЕПОК, СОГЛАСНО СПЕЦИФИКАЦИИ КЛИЕНТА

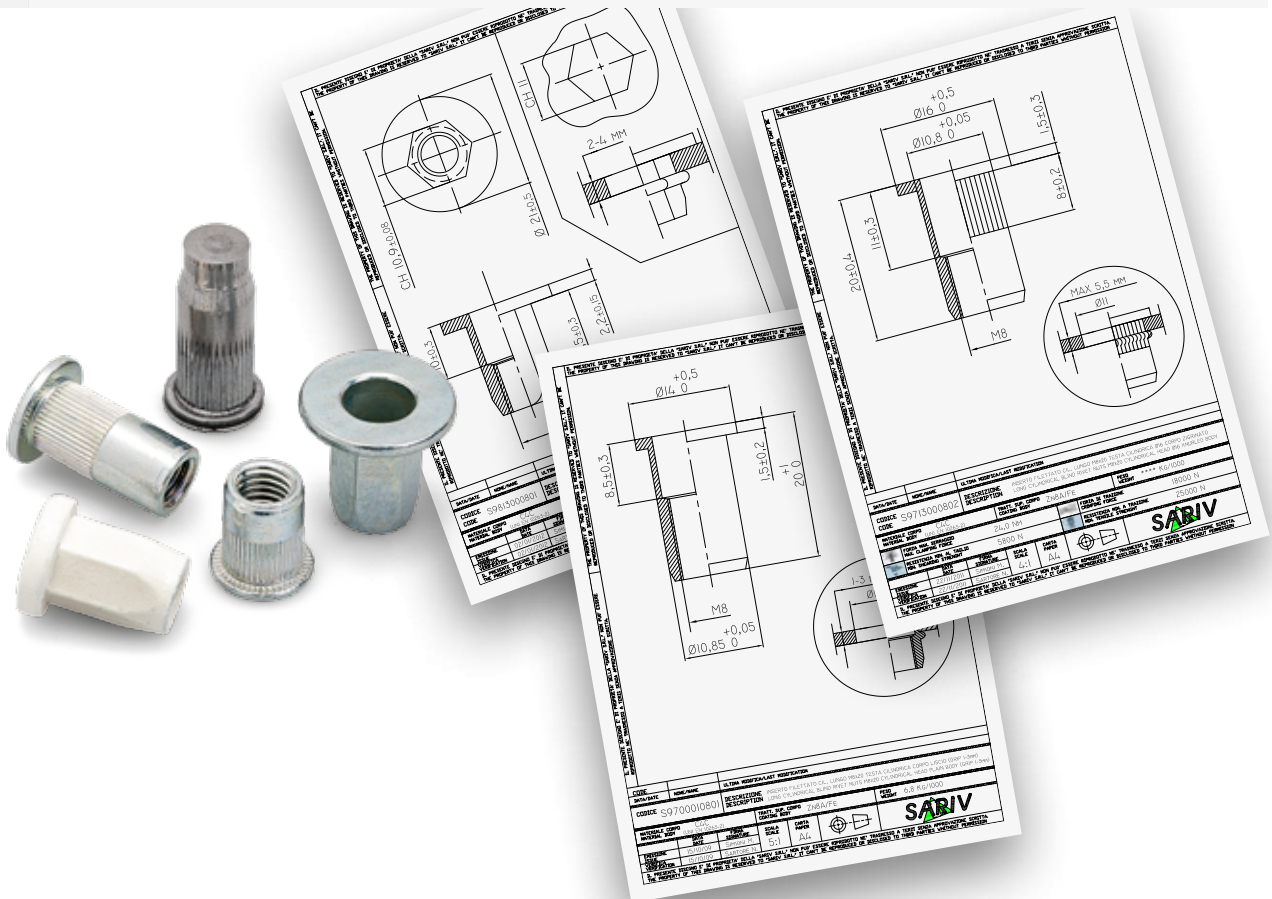



# SARIV ACC-CTC-Z

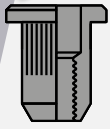

ZINC PLATED STEEL  
ACCIAIO ZINCATO  
ACIER ZINGUÉ  
VERZINKTER STAHL  
ОЦИНКОВАННАЯ СТАЛЬ

CYLINDRICAL BLIND RIVET NUTS  
INSERTI FILETTATI CILINDRICI  
ÉCROUS À SERTIR CYLINDRIQUES  
RUND BLINDNIETMUTTER  
ЦИЛИНДРИЧЕСКИЕ ГАЕЧНЫЕ ЗАКЛЕПКИ

CYLINDRICAL HEAD  
TESTA CILINDRICA  
TÊTE CYLINDRIQUE  
ZYLINDRISCHER KOPF  
СТАНДАРТНЫЙ БОРТИК

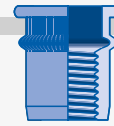

KNURLED BODY  
CORPO ZIGRINATO  
FÛT CRANTÉ  
GERÄNDELTE SCHAFT  
С НАСЕЧКОЙ

M	Ø mm	N	N
M4	6	7.000	2.500
M5	7	11.000	3.400
M6	9	16.000	4.600
M8	11	22.000	5.800

M	L mm	mm	min-max mm	€/1000	1.000 Kg.	SARIV box Cod.	Pcs x SARIV box	Pcs Outer box	Industrial box Cod.	Pz x I-box
M4	11	9	0.3 - 2.5		1.35	V97000004	1.000	12.000	I97000004	15.000
	13		2.5 - 4		1.45	V97100004			I97100004	
M5	13	10	0.5 - 3		1.85	V97000005	1.000	12.000	I97000005	10.000
	16		3 - 5		1.95	V97100005		8.000	I97100005	
M6	16	12	0.5 - 3		3.74	V97000006	500	6.000	I97000006	7.000
	18		3 - 6		3.94	V97100006		4.000	I97100006	6.000
M8	17	14	0.5 - 3		5.44	V97000008	500	4.000	I97000008	4.000
	20		3 - 6		5.64	V97100008	250	2.000	I97100008	3.000

# SARIV ACC-CTC-L

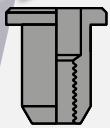

ZINC PLATED STEEL  
ACCIAIO ZINCATO  
ACIER ZINGUÉ  
VERZINKTER STAHL  
ОЦИНКОВАННАЯ СТАЛЬ

CYLINDRICAL BLIND RIVET NUTS  
INSERTI FILETTATI CILINDRICI  
ÉCROUS À SERTIR CYLINDRIQUES  
RUND BLINDNIETMUTTER  
ЦИЛИНДРИЧЕСКИЕ ГАЕЧНЫЕ ЗАКЛЕПКИ

CYLINDRICAL HEAD  
TESTA CILINDRICA  
TÊTE CYLINDRIQUE  
ZYLINDRISCHER KOPF  
СТАНДАРТНЫЙ БОРТИК



PLAIN BODY  
CORPO LISCIO  
FÛT LISSE  
GLATT SCHAFT  
ГЛАДКИЕ

M	Ø mm	N	N
M3	5	3.800	1.400
M4	6	7.000	2.500
M5	7	11.000	3.400
M6	9	16.000	4.600
M8	11	22.000	5.800
M10A	12	24.000	6.400
M10B	13	27.000	7.250

M	L mm	mm	min-max mm	€/1000	1.000 Kg.	SARIV box Cod.	Pcs x SARIV box	Pcs Outer box	Industrial box Cod.	Pz x I-box
M3	8.5	7	0.3 - 2		0.85	V97000103	1.000	12.000	I97000103	20.000
M4	11	9	0.3 - 2.5		1.35	V97000104	1.000	12.000	I97000104	15.000
M5	13	10	0.5 - 3		1.85	V97000105	1.000	12.000	I97000105	10.000
M6	16	12	0.5 - 3		3.74	V97000106	500	6.000	I97000106	7.000
M8	17	14	0.5 - 3		5.44	V97000108	500	4.000	I97000108	4.000
M10	19	16	1 - 3.5		6.50	V97000110A	250	2.000	I97000110A	3.000
M10	21	17	1 - 3.5		9.00	V97000110B	250	2.000	I97000110B	3.000

# SARIV ACC-CTR-Z

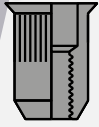

ZINC PLATED STEEL  
ACCIAIO ZINCATO  
ACIER ZINGUÉ  
VERZINKTER STAHL  
ОЦИНКОВАННАЯ СТАЛЬ

CYLINDRICAL BLIND RIVET NUTS  
INSERTI FILETTATI CILINDRICI  
ÉCROUS À SERTIR CYLINDRIQUES  
RUND BLINDNIETMUTTER  
ЦИЛИНДРИЧЕСКИЕ ГАЕЧНЫЕ ЗАКЛЕПКИ

REDUCED HEAD  
TESTA RIDOTTA  
TÊTE RÉDUITE  
REDUZIERTER KOPF  
УМЕНЬШЕННЫЙ БОРТИК

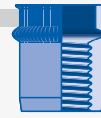

KNURLED BODY  
CORPO ZIGRINATO  
FÛT CRANTÉ  
GERÄNDELT SCHAFT  
С НАСЕЧКОЙ

M	Ø mm	N	N
M4	6	7.000	2.500
M5	7	11.000	3.400
M6	9	16.000	4.600
M8	11	22.000	5.800

M	L mm	mm	min-max mm	€/1000	1.000 Kg.	SARIV box Cod.	Pcs x SARIV box	Pcs Outer box	Industrial box Cod.	Pz x I-box
M4	10.5	7	0.5 - 2		1.30	V97040004	1.000	12.000	197040004	15.000
	12.5		1.5 - 4		1.40	V97140004			197140004	
M5	12	8	0.5 - 2.5		1.74	V97040005	1.000	12.000	197040005	10.000
	14		2 - 4.5		1.84	V97140005		8.000	197140005	
M6	15	10	0.5 - 2.5		3.51	V97040006	500	6.000	197040006	7.000
	17		2.5 - 5.5		3.71	V97140006		4.000	197140006	6.000
M8	16	12	0.5 - 3.5		4.87	V97040008	500	4.000	197040008	4.000
	18		3 - 6		5.07	V97140008	250	2.000	197140008	3.000

# SARIV ACC-CTR-L

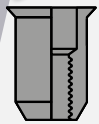

ZINC PLATED STEEL  
ACCIAIO ZINCATO  
ACIER ZINGUÉ  
VERZINKTER STAHL  
ОЦИНКОВАННАЯ СТАЛЬ

CYLINDRICAL BLIND RIVET NUTS  
INSERTI FILETTATI CILINDRICI  
ÉCROUS À SERTIR CYLINDRIQUES  
RUND BLINDNIETMUTTER  
ЦИЛИНДРИЧЕСКИЕ ГАЕЧНЫЕ ЗАКЛЕПКИ

REDUCED HEAD  
TESTA RIDOTTA  
TÊTE RÉDUITE  
REDUZIERTER KOPF  
УМЕНЬШЕННЫЙ БОРТИК



PLAIN BODY  
CORPO LISCIO  
FÛT LISSE  
GLATT SCHAFT  
ГЛАДКИЕ

M	Ø mm	N	N
M3	5	3.800	1.400
M4	6	7.000	2.500
M5	7	11.000	3.400
M6	9	16.000	4.600
M8	11	22.000	5.800
M10A	12	24.000	6.400
M10B	13	27.000	7.250

M	L mm	mm	min-max mm	€/1000	1.000 Kg.	SARIV box Cod.	Pcs x SARIV box	Pcs Outer box	Industrial box Cod.	Pz x I-box
M3	8.5	6	0.5 - 1.5		0.80	V97040103	1.000	12.000	197040103	20.000
M4	10.5	7	0.5 - 2		1.30	V97040104	1.000	12.000	197040104	15.000
M5	12	8	0.5 - 2.5		1.74	V97040105	1.000	12.000	197040105	10.000
M6	15	10	0.5 - 2.5		3.51	V97040106	500	6.000	197040106	7.000
M8	16	12	0.5 - 3.5		4.87	V97040108	500	4.000	197040108	4.000
M10	19	13.5	0.5 - 3		5.60	V97040110A	250	2.000	197040110A	3.000
M10	20	13.5	0.5 - 3		7.60	V97040110B	250	2.000	197040110B	3.000

# SARIV ACC-CTS-Z

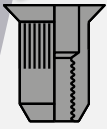

ZINC PLATED STEEL  
ACCIAIO ZINCATO  
ACIER ZINGUÉ  
VERZINKTER STAHL  
ОЦИНКОВАННАЯ СТАЛЬ

CYLINDRICAL BLIND RIVET NUTS  
INSERTI FILETTATI CILINDRICI  
ÉCROUS À SERTIR CYLINDRIQUES  
RUND BLINDNIETMUTTER  
ЦИЛИНДРИЧЕСКИЕ ГАЕЧНЫЕ ЗАКЛЕПКИ

COUNTERSUNK HEAD (90°)  
TESTA SVASATA (90°)  
TÊTE FRAISÉE (90°)  
SENKKOPF (90°)  
ПОТайНОЙ БОРТИК (90°)



KNURLED BODY  
CORPO ZIGRINATO  
FÛT CRANTÉ  
GERÄNDELTE SCHAFT  
С НАСЕЧКОЙ

M	Ø mm	N	N
M4	6	7.000	2.500
M5	7	11.000	3.400
M6	9	16.000	4.600
M8	11	22.000	5.800

M	L mm	mm	min-max mm	€/1000	1.000 Kg.	SARIV box Cod.	Pcs x SARIV box	Pcs Outer box	Industrial box Cod.	Pz x I-box
M4	11	8.5	1.5 - 3.5		1.38	V97010004	1.000	12.000	197010004	15.000
	13		3.5 - 5		1.48	V97110004			197110004	
M5	13	9.5	1.5 - 4		1.89	V97010005	1.000	12.000	197010005	10.000
	15		3.5 - 6		1.99	V97110005		8.000	197110005	
M6	16	11.5	1.5 - 4		3.81	V97010006	500	6.000	197010006	7.000
	18		4 - 6		4.01	V97110006		4.000	197110006	6.000
M8	17	13.5	1.5 - 4		5.27	V97010008	500	4.000	197010008	4.000
	20		4 - 6		5.47	V97110008	250	2.000	197110008	3.000

# SARIV ACC-CTS-L

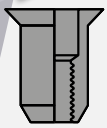

ZINC PLATED STEEL  
ACCIAIO ZINCATO  
ACIER ZINGUÉ  
VERZINKTER STAHL  
ОЦИНКОВАННАЯ СТАЛЬ

CYLINDRICAL BLIND RIVET NUTS  
INSERTI FILETTATI CILINDRICI  
ÉCROUS À SERTIR CYLINDRIQUES  
RUND BLINDNIETMUTTER  
ЦИЛИНДРИЧЕСКИЕ ГАЕЧНЫЕ ЗАКЛЕПКИ

COUNTERSUNK HEAD (90°)  
TESTA SVASATA (90°)  
TÊTE FRAISÉE (90°)  
SENKKOPF (90°)  
ПОТайНОЙ БОРТИК (90°)



PLAIN BODY  
CORPO LISCIO  
FÛT LISSE  
GLATT SCHAFT  
ГЛАДКИЕ

M	Ø mm	N	N
M4	6	7.000	2.500
M5	7	11.000	3.400
M6	9	16.000	4.600
M8	11	22.000	5.800

M	L mm	mm	min-max mm	€/1000	1.000 Kg.	SARIV box Cod.	Pcs x SARIV box	Pcs Outer box	Industrial box Cod.	Pz x I-box
M4	11	8.5	1.5 - 3.5		1.38	V97010104	1.000	12.000	197010104	15.000
M5	13	9.5	1.5 - 4		1.89	V97010105	1.000	12.000	197010105	10.000
M6	16	11.5	1.5 - 4		3.81	V97010106	500	6.000	197010106	7.000
M8	17	13.5	1.5 - 4		5.27	V97010108	500	4.000	197010108	4.000

# SARIV ACC-ETC

ZINC PLATED STEEL  
ACCIAIO ZINCATO  
ACIER ZINGUÉ  
VERZINKTER STAHL  
ОЦИНКОВАННАЯ СТАЛЬ

HEXAGONAL BLIND RIVET NUTS  
INSERTI FILETTATI ESAGONALI  
ÉCROUS À SERTIR HEXAGONAUX  
BLINDNIETMUTTER, SCHAFT 6-KT.  
ШЕСТИГРАННЫЕ ГАЕЧНЫЕ ЗАКЛЕПКИ

CYLINDRICAL HEAD  
TESTA CILINDRICA  
TÊTE CYLINDRIQUE  
ZYLINDRISCHER KOPF  
СТАНДАРТНЫЙ БОРТИК



M	Ø mm	N	N
M4	6	6.500	2.300
M5	7	10.800	3.200
M6	9	15.500	4.400
M8	11	22.000	5.600
M10A	12	24.000	6.200
M10B	13	27.000	7.000

M	L mm	mm	min-max mm	€/1000	1.000 Kg.	SARIV box Cod.	Pcs x SARIV box	Pcs Outer box	Industrial box Cod.	Pz x I-box
M4	11	9	0.5 - 2.5		1.50	V98000004	1.000	12.000	I98000004	15.000
M5	14	10	0.5 - 3		2.40	V98000005	500	6.000	I98000005	10.000
M6	16	12	0.5 - 3		4.60	V98000006	500	4.000	I98000006	6.000
M8	17	14	0.5 - 3		6.70	V98000008	250	2.000	I98000008	3.000
M10	20.5	18	1 - 3.5		8.50	V98000010A	200	1.600	I98000010A	2.500
M10	21	18	1 - 3.5		10.70	V98000010B	200	1.600	I98000010B	2.500

# SARIV ACC-ETR

ZINC PLATED STEEL  
ACCIAIO ZINCATO  
ACIER ZINGUÉ  
VERZINKTER STAHL  
ОЦИНКОВАННАЯ СТАЛЬ

HEXAGONAL BLIND RIVET NUTS  
INSERTI FILETTATI ESAGONALI  
ÉCROUS À SERTIR HEXAGONAUX  
BLINDNIETMUTTER, SCHAFT 6-KT.  
ШЕСТИГРАННЫЕ ГАЕЧНЫЕ ЗАКЛЕПКИ

REDUCED HEAD  
TESTA RIDOTTA  
TÊTE RÉDUITE  
REDUZIRTER KOPF  
УМЕНЬШЕННЫЙ БОРТИК



M	Ø mm	N	N
M4	6	6.500	2.300
M5	7	10.800	3.200
M6	9	15.500	4.400
M8	11	22.000	5.600

M	L mm	mm	min-max mm	€/1000	1.000 Kg.	SARIV box Cod.	Pcs x SARIV box	Pcs Outer box	Industrial box Cod.	Pz x I-box
M4	10	7	0.3 - 2.5		1.40	V98040004	1.000	12.000	I98040004	15.000
M5	14	8	0.5 - 3		2.20	V98040005	1.000	12.000	I98040005	10.000
M6	16	10	0.5 - 3		4.30	V98040006	500	6.000	I98040006	6.000
M8	17	12	0.5 - 3		6.40	V98040008	500	4.000	I98040008	4.000

# SARIV ACC-CETC-Z

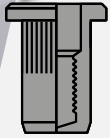

ZINC PLATED STEEL  
ACCIAIO ZINCATO  
ACIER ZINGUÉ  
VERZINKTER STAHL  
ОЦИНКОВАННАЯ СТАЛЬ

CLOSED CYLINDRICAL BLIND RIVET NUTS  
INSERTI CHIUSI FILETTATI CILINDRICI  
ÉCROUS À SERTIR CYLINDRIQUES ÉTANCHES  
GESCHLOSSEN BLINDNIEMUTTER, RUND SCHAFT  
ЗАКРЫТЫЕ ЦИЛИНДРИЧЕСКИЕ ГАЕЧНЫЕ ЗАКЛЕПКИ

CYLINDRICAL HEAD  
TESTA CILINDRICA  
TÊTE CYLINDRIQUE  
ZYLINDRISCHER KOPF  
СТАНДАРТНЫЙ БОРТИК

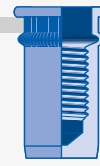

KNURLED BODY  
CORPO ZIGRINATO  
FÛT CRANTÉ  
GERÄNDELT SCHAFT  
С НАСЕЧКОЙ

M	Ø mm	N	N
M4	6	7.000	2.500
M5	7	11.000	3.400
M6	9	16.000	4.600
M8	11	22.000	5.800

M	L mm	mm	min-max mm	€/1000	1.000 Kg.	SARIV box Cod.	Pcs x SARIV box	Pcs Outer box	Industrial box Cod.	Pz x I-box
M4	16.5	9	0.3 - 2.5		2.10	V97070004	500	6.000	197070004	11.000
	18		2.5 - 4		2.30	V97170004			197170004	
M5	18	10	0.5 - 3		2.95	V97070005	500	6.000	197070005	8.000
	20.5		3 - 5		3.15	V97170005			197170005	
M6	22.5	12	0.5 - 3		6.35	V97070006	500	4.000	197070006	4.000
	24.5		3 - 6		6.60	V97170006			197170006	
M8	25.5	14	0.5 - 3		9.40	V97070008	250	2.000	197070008	2.500
	28		3 - 6		9.80	V97170008			197170008	

# SARIV ACC-EETC

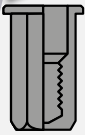

ZINC PLATED STEEL  
ACCIAIO ZINCATO  
ACIER ZINGUÉ  
VERZINKTER STAHL  
ОЦИНКОВАННАЯ СТАЛЬ

INSERTI CHIUSI FILETTATI ESAGONALI  
CLOSED HEXAGONAL BLIND RIVET NUTS  
ÉCROUS À SERTIR HEXAGONAUX ÉTANCHES  
GESCHLOSSEN BLINDNIEMUTTER, SCHAFT 6-KT.  
ЗАКРЫТЫЕ ШЕСТИГРАННЫЕ ГАЕЧНЫЕ ЗАКЛЕПКИ

CYLINDRICAL HEAD  
TESTA CILINDRICA  
TÊTE CYLINDRIQUE  
ZYLINDRISCHER KOPF  
СТАНДАРТНЫЙ БОРТИК



M	Ø mm	N	N
M4	6	7.000	2.500
M5	7	11.000	3.400
M6	9	16.000	4.600
M8	11	22.000	5.800

M	L mm	mm	min-max mm	€/1000	1.000 Kg.	SARIV box Cod.	Pcs x SARIV box	Pcs Outer box	Industrial box Cod.	Pz x I-box
M4	16	9	0.5 - 2.5		2.30	V98070004	500	6.000	198070004	10.000
M5	20	10	0.5 - 3		3.55	V98070005	500	6.000	198070005	7.000
M6	22	12	0.5 - 3		6.60	V98070006	500	4.000	198070006	4.000
M8	26	14	0.5 - 3		11.30	V98070008	200	1.600	198070008	2.000

# SARIV INOX-CTC-Z

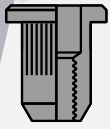

INOX A2  
INOX A2  
INOX A2  
EDELSTAHL A2  
НЕРЖ.СТАЛЬ A2

CYLINDRICAL BLIND RIVET NUTS  
INSERTI FILETTATI CILINDRICI  
ÉCROUS À SERTIR CYLINDRIQUES  
RUND BLINDNIETMUTTER  
ЦИЛИНДРИЧЕСКИЕ ГАЕЧНЫЕ ЗАКЛЕПКИ

CYLINDRICAL HEAD  
TESTA CILINDRICA  
TÊTE CYLINDRIQUE  
ZYLINDRISCHER KOPF  
СТАНДАРТНЫЙ БОРТИК

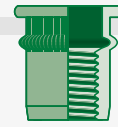

KNURLED BODY  
CORPO ZIGRINATO  
FÛT CRANTÉ  
GERÄNDELTE SCHAFT  
С НАСЕЧКОЙ

M	Ø mm	N	N
M4	6	6.500	3.000
M5	7	11.000	4.000
M6	9	21.000	5.600
M8	11	26.500	7.000

M	L mm	mm	min-max mm	€/1000	1.000 Kg.	SARIV box Cod.	Pcs x SARIV box	Pcs Outer box	Industrial box Cod.	Pz x I-box
M4	11	9	0.5 - 2.5		1.35	V95000004	1.000	12.000	I95000004	15.000
M5	13	10	0.5 - 3.0		1.85	V95000005	1.000	12.000	I95000005	10.000
M6	16	12	0.5 - 3.0		3.75	V95000006	500	6.000	I95000006	7.000
M8	17	15	0.5 - 3.5		5.45	V95000008	500	4.000	I95000008	4.000

# SARIV ALU-CTC-L

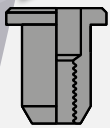

ALUMINIUM  
ALLUMINIO  
ALUMINIUM  
ALUMINIUM  
АЛЮМИНИЙ

CYLINDRICAL BLIND RIVET NUTS  
INSERTI FILETTATI CILINDRICI  
ÉCROUS À SERTIR CYLINDRIQUES  
RUND BLINDNIETMUTTER  
ЦИЛИНДРИЧЕСКИЕ ГАЕЧНЫЕ ЗАКЛЕПКИ

CYLINDRICAL HEAD  
TESTA CILINDRICA  
TÊTE CYLINDRIQUE  
ZYLINDRISCHER KOPF  
СТАНДАРТНЫЙ БОРТИК

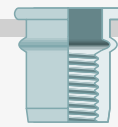

PLAIN BODY  
CORPO LISCIO  
FÛT LISSE  
GLATT SCHAFT  
ГЛАДКИЕ

M	Ø mm	N	N
M4	6	4.000	1.500
M5	7	5.500	2.000
M6	9	7.500	2.800
M8	11	12.000	3.500

M	L mm	mm	min-max mm	€/1000	1.000 Kg.	SARIV box Cod.	Pcs x SARIV box	Pcs Outer box	Industrial box Cod.	Pz x I-box
M4	11	9				V92000104	1.000		I92000104	15.000
M5	13	10				V92000105	1.000		I92000105	10.000
M6	16	12				V92000106	500		I92000106	7.000
M8	17	14				V92000108	500		I92000108	4.000



**RIVETING TOOLS FOR BLIND RIVETS**  
**RIVETTATRICI PER RIVETTI A STRAPPO**  
**PINCES ET PISTOLETS POUR RIVETS**  
**WERKZEUGE FÜR BLINDNIETE**  
**ЗАКЛЕПОЧНИКИ ДЛЯ ВЫТЯЖНЫХ ЗАКЛЕПОК**

**HAND RIVETING TOOLS**  
**RIVETTATRICI MANUALI**

**МЕХАНИЧЕСКИЕ ЗАКЛЕПОЧНИКИ**

## SAR006

**HAND RIVETING TOOL**  
**RIVETTATRICE MANUALE**  
**ЗАКЛЕПОЧНИК МЕХАНИЧЕСКИЙ РУЧНОЙ**

Tool lenght mm Lunghezza mm	260
Tool Weight kg Peso kg	0.55
PRICE € PREZZO €	



Ø	ALLUMINIO ALUMINIUM	ACCIAIO STEEL	ACCIAIO INOX STAINLESS STEEL	RAME COPPER	CU.NI.
2,4	■	■	■	■	■
3	■	■	■	■	■
3,2	■	■	■	■	■
3,4	■	■	■	■	■
4	■	■	■	■	■
4,8 / 5	■				
6					
6,4					
7,8					

## SAR003

**LONG-ARMS RIVETING TOOL**  
**RIVETTATRICE LEVE LUNGHE**  
**ЗАКЛЕПОЧНИК МЕХАНИЧЕСКИЙ ДВУРУЧНЫЙ**

Tool lenght mm Lunghezza mm	530
Tool Weight kg Peso kg	1.85
PRICE € PREZZO €	



Ø	ALLUMINIO ALUMINIUM	ACCIAIO STEEL	ACCIAIO INOX STAINLESS STEEL	RAME COPPER	CU.NI.
2,4					
3	■	■	■	■	■
3,2	■	■	■	■	■
3,4	■	■	■	■	■
4	■	■	■	■	■
4,8 / 5	■	■	■	■	■
6	■	■	■	■	■
6,4	■	■	■	■	■
7,8	■				

## SAR007

**EXTENSIBLE RIVETING TOOL**  
**RIVETTATRICE A ESTENSIONE**  
**ЗАКЛЕПОЧНИК МЕХАНИЧЕСКИЙ "ГАРМОШКА"**

Tool lenght mm Lunghezza mm	320 - 820
Tool Weight kg Peso kg	1.95
PRICE € PREZZO €	

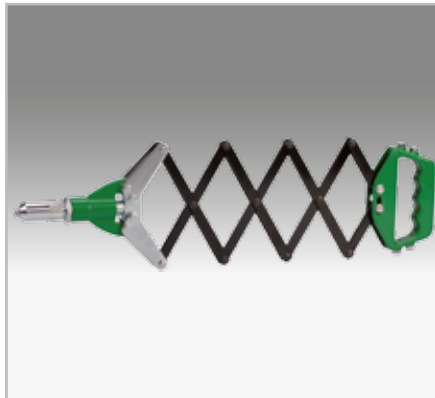

Ø	ALLUMINIO ALUMINIUM	ACCIAIO STEEL	ACCIAIO INOX STAINLESS STEEL	RAME COPPER	CU.NI.
2,4					
3	■	■	■	■	■
3,2	■	■	■	■	■
3,4	■	■	■	■	■
4	■	■	■	■	■
4,8 / 5	■	■	■	■	■
6	■	■	■	■	■
6,4	■	■	■	■	■
7,8	■				



**RIVETING TOOLS FOR BLIND RIVETS**  
**RIVETTATRICI PER RIVETTI A STRAPPO**  
**PINCES ET PISTOLETS POUR RIVETS**  
**WERKZEUGE FÜR BLINDNIETE**  
**ЗАКЛЕПОЧНИКИ ДЛЯ ВЫТЯЖНЫХ ЗАКЛЕПОК**

**HYDROPNEUMATIC RIVETING TOOLS**  
**RIVETTATRICI OLEOPNEUMATICHE**

**ГИДРОПНЕВМАТИЧЕСКИЕ ЗАКЛЕПОЧНИКИ**

# SAR008

**HYDROPNEUMATIC RIVETING TOOL**  
**RIVETTATRICE OLEOPNEUMATICA**  
**ГИДРОПНЕВМАТИЧЕСКИЙ ЗАКЛЕПОЧНИК**

Tool length mm Lunghezza mm	332
Tool Weight kg Peso kg	1,7
PRICE € PREZZO €	



Ø	ALLUMINIO ALUMINIUM	ACCIAIO STEEL	ACCIAIO INOX STAINLESS STEEL	RAME COPPER	CU.NI.
2,4					
3	■	■	■	■	■
3,2	■	■	■	■	■
3,4	■	■	■	■	■
4	■	■	■	■	■
4,8 / 5	■	■	■	■	■
6	■	■	■	■	■
6,4	■	■	■	■	■
7,8	■				

# SAR002

**HYDROPNEUMATIC RIVETING TOOL**  
**RIVETTATRICE OLEOPNEUMATICA**  
**ГИДРОПНЕВМАТИЧЕСКИЙ ЗАКЛЕПОЧНИК**

Tool length mm Lunghezza mm	230
Tool Weight kg Peso kg	1,3
PRICE € PREZZO €	



Ø	ALLUMINIO ALUMINIUM	ACCIAIO STEEL	ACCIAIO INOX STAINLESS STEEL	RAME COPPER	CU.NI.
2,4	■	■	■	■	■
3	■	■	■	■	■
3,2	■	■	■	■	■
3,4	■	■	■	■	■
4	■	■	■	■	■
4,8 / 5	■				
6					
6,4					
7,8					



**RIVETING TOOLS FOR BLIND RIVET NUTS**  
**RIVETTATRICI PER INSERTI FILETTATI**  
**PINCES ET PISTOLETS POUR ÉCROUS**  
**WERKZEUGE FÜR BLIND-EINNIETMUTTERN**  
**ЗАКЛЕПОЧНИКИ ДЛЯ ГАЕЧНЫХ ЗАКЛЕПОК**

# SAR004

**LONG-ARMS RIVETING TOOL FOR BLIND RIVETS NUTS**  
**RIVETTATRICE LEVE LUNGHE PER INSERTI**  
**ЗАКЛЕПОЧНИК МЕХАНИЧЕСКИЙ ДВУРУЧНЫЙ ДЛЯ**  
**ГАЕЧНЫХ ЗАКЛЕПОК**

Tool length mm Lunghezza mm	530
Tool Weight kg Peso kg	2,3
PRICE € PREZZO €	



M	ALLUMINIO ALUMINIUM	ACCIAIO STEEL	ACCIAIO INOX STAINLESS STEEL		
M3					
M4	■	■	■		
M5	■	■	■		
M6	■	■	■		
M8	■	■	■		
M10	■	■	■		
M12					

# SAR001

**HYDROPNEUMATIC TOOL FOR BLIND RIVETS NUTS**  
**RIVETTATRICE OLEOPNEUMATICA PER INSERTI**  
**ГИДРОПНЕВМАТИЧЕСКИЙ ЗАКЛЕПОЧНИК ДЛЯ**  
**ГАЕЧНЫХ ЗАКЛЕПОК**

Tool length mm Lunghezza mm	270
Tool Weight kg Peso kg	2,5
PRICE € PREZZO €	



M	ALLUMINIO ALUMINIUM	ACCIAIO STEEL	ACCIAIO INOX STAINLESS STEEL		
M3	■	■	■		
M4	■	■	■		
M5	■	■	■		
M6	■	■	■		
M8	■	■	■		
M10	■	■	■		
M12	■	■	■		



SARIV

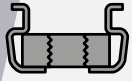

# STEEL ZINC PLATED CAGE NUTS

## DADI IN GABBIA IN ACCIAIO ZINCATO

### ГАЙКИ КЛЕТЕВЫЕ СТАЛЬНЫЕ

#### (КУЗОВНЫЕ, ЗАКЛАДНЫЕ)

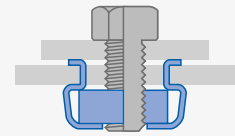

NUTS WITH FASTENERS  
DADI IN GABBIA  
ÉCROUS-CAGE  
KÄFIGMUTTERN  
КЛЕТЕВЫЕ ГАЙКИ

M	HOLE mm	min-max mm	€/1000	1.000 Kg.	SARIV box Cod.	Pcs x SARIV box			
M4	8.3 x 8.3	0.7 - 1.6		3.80	DG11M4-2B	5.000			
		1.7 - 2.5		4.00	DG11M4-2C	5.000			
M5	8.3 x 8.3	0.7 - 1.6		3.90	DG11M5-2B	5.000			
		1.7 - 2.5		3.80	DG11M5-2C	5.000			
M6	8.3 x 8.3	0.7 - 1.6		3.50	DG11M6-2B	5.000			
		1.7 - 2.5		3.65	DG11M6-2C	5.000			
		2.6 - 3.5		3.70	DG11M6-2D	5.000			
M5	9.0 x 9.0	0.7 - 1.6		4.40	DG11M5-3A	5.000			
		1.7 - 2.6		4.60	DG11M5-3B	5.000			
M6	9.0 x 9.0	0.7 - 1.6		4.45	DG11M6-3A	5.000			
		1.7 - 2.6		4.55	DG11M6-3B	5.000			
M5	9.5 x 9.5	0.7 - 1.6		4.60	DG11M5-4A	5.000			
		1.7 - 2.6		4.70	DG11M5-4B	5.000			
M6	9.5 x 9.5	0.7 - 1.6		4.40	DG11M6-4A	5.000			
		1.7 - 2.6		4.50	DG11M6-4B	5.000			
		2.7 - 3.5		4.60	DG11M6-4C	5.000			
M8	12.3x12.3	0.7 - 1.7		8.00	DG11M8-5A	2.500			
		1.8 - 3.1		8.50	DG11M8-5B	2.500			
M10	12.3x12.3	3.2 - 4.3		8.60	DG11M8-5C	2.500			
		0.7 - 1.7		7.85	DG11M10-5A	2.500			
		1.8 - 3.1		8.15	DG11M10-5B	2.500			



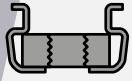

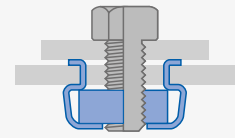

SARIV



# STEEL ZINC PLATED CAGE NUTS DADI IN GABBIA IN ACCIAIO ZINCATO ГАЙКИ КЛЕТЕВЫЕ СТАЛЬНЫЕ (КУЗОВНЫЕ, ЗАКЛАДНЫЕ)

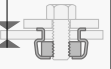

NUTS WITH FASTENERS  
DADI IN GABBIA  
ÉCROUS-CAGE  
ΚΑΪΓΙΜΥΤΤΕΡΝ  
КЛЕТЕВЫЕ ГАЙКИ

M							Pcs x SARIV box		
		HOLE mm	min-max mm	€/1000	Kg.	SARIV box Cod.			
			1.0 - 1.7		14.00	<b>DG11M12-6A</b>	1.000		
<b>M12</b>		14 x 14	1.8 - 3.2		14.00	<b>DG11M12-6B</b>	1.000		
			3.3 - 4.7		14.00	<b>DG11M12-6C</b>	1.000		

# STEEL SPRING PINS

## SPINE ELASTICHE IN ACCIAIO

### ШТИФТЫ РАЗРЕЗНЫЕ

### ПРУЖИННЫЕ СТАЛЬНЫЕ

SPRING PINS  
SPINE ELASTICHE  
GOUPILLES ELASTIQUES  
SPANNSTIFTE  
ШТИФТЫ РАЗРЕЗНЫЕ

C	L	1.000 €/1000	SARIV box Kg.	Pcs x
1.5	4	0.034	SE01504	5.000
	5	0.043	SE01505	5.000
	6	0.051	SE01506	5.000
	8	0.068	SE01508	5.000
	10	0.085	SE01510	5.000
	12	0.103	SE01512	5.000
	14	0.120	SE01514	5.000
	16	0.137	SE01516	5.000
	18	0.154	SE01518	5.000
	20	0.171	SE01520	2.500
	22	0.187	SE01522	2.500
	24	0.204	SE01524	2.500
	26	0.221	SE01526	2.500
	28	0.238	SE01528	2.500
30	0.255	SE01530	2.500	
2	4	0.061	SE02004	5.000
	5	0.077	SE02005	5.000
	6	0.092	SE02006	5.000
	8	0.122	SE02008	5.000
	10	0.153	SE02010	5.000
	12	0.184	SE02012	5.000
	14	0.214	SE02014	2.500
	16	0.244	SE02016	2.500
	18	0.275	SE02018	2.500
	20	0.305	SE02020	2.500
	22	0.336	SE02022	2.500
	24	0.367	SE02024	2.500
	26	0.397	SE02026	2.500
	28	0.427	SE02028	2.500
30	0.458	SE02030	2.000	

C	L	1.000 €/1000	SARIV box Kg.	Pcs x
2.5	4	0.095	SE02504	5.000
	5	0.118	SE02505	5.000
	6	0.142	SE02506	5.000
	8	0.189	SE02508	5.000
	10	0.236	SE02510	2.500
	12	0.283	SE02512	2.500
	14	0.330	SE02514	2.500
	16	0.377	SE02516	2.500
	18	0.424	SE02518	2.500
	20	0.471	SE02520	5.000
	22	0.519	SE02522	5.000
	24	0.565	SE02524	5.000
	26	0.613	SE02526	4.000
	28	0.660	SE02528	4.000
30	0.707	SE02530	4.000	
40	0.943	SE02540	3.000	
3	4	0.136	SE03004	5.000
	5	0.170	SE03005	5.000
	6	0.204	SE03006	5.000
	8	0.272	SE03008	5.000
	10	0.340	SE03010	5.000
	12	0.407	SE03012	5.000
	14	0.457	SE03014	5.000
	16	0.543	SE03016	5.000
	18	0.611	SE03018	5.000
	20	0.679	SE03020	5.000
	22	0.746	SE03022	3.000
	24	0.814	SE03024	3.000
	25	0.850	SE03025	3.000
	26	0.882	SE03026	3.000
28	0.950	SE03028	3.000	
30	1.020	SE03030	2.000	
32	1.220	SE03032	2.000	
34	1.255	SE03034	2.000	
36	1.290	SE03036	2.000	
40	1.365	SE03040	2.000	
50	1.700	SE03050	1.500	

# STEEL SPRING PINS

## SPINE ELASTICHE IN ACCIAIO

### ШТИФТЫ РАЗРЕЗНЫЕ

### ПРУЖИННЫЕ СТАЛЬНЫЕ

SPRING PINS  
SPINE ELASTICHE  
GOUPILLES ELASTIQUES  
SPANNSTIFTE  
ШТИФТЫ РАЗРЕЗНЫЕ

∅	L	1.000 €/1000	SARIV box Kg.	Pcs x
	5	0.246	SE03505	5.000
	6	0.296	SE03506	5.000
	8	0.394	SE03508	5.000
	10	0.493	SE03510	5.000
	12	0.591	SE03512	5.000
	14	0.689	SE03514	5.000
	16	0.788	SE03516	5.000
	18	0.886	SE03518	5.000
3.5	20	0.985	SE03520	3.000
	22	1.080	SE03522	3.000
	24	1.180	SE03524	3.000
	26	1.280	SE03526	3.000
	28	1.380	SE03528	3.000
	30	1.480	SE03530	2.000
	32	1.580	SE03532	2.000
	36	1.770	SE03536	2.000
	40	1.970	SE03540	2.000
	50	2.470	SE03550	1.500
	4	0.239	SE04004	5.000
	5	0.299	SE04005	5.000
	6	0.358	SE04006	5.000
	8	0.478	SE04008	6.000
	10	0.597	SE04010	6.000
	12	0.716	SE04012	6.000
	14	0.836	SE04014	5.000
	16	0.955	SE04016	3.000
	18	1.070	SE04018	3.000
	20	1.190	SE04020	3.000
4	22	1.310	SE04022	3.000
	24	1.430	SE04024	2.000
	26	1.550	SE04026	2.000
	28	1.670	SE04028	2.000
	30	1.790	SE04030	1.500
	32	1.910	SE04032	1.500
	34	2.045	SE04034	1.500
	36	2.180	SE04036	1.500
	40	2.390	SE04040	1.500
	45	2.680	SE04045	1.000
	50	2.980	SE04050	1.000
	60	3.450	SE04060	1.000

∅	L	1.000 €/1000	SARIV box Kg.	Pcs x
	4	0.377	SE05004	3.000
	5	0.471	SE05005	3.000
	6	0.566	SE05006	3.000
	8	0.754	SE05008	3.000
	10	0.942	SE05010	3.000
	12	1.130	SE05012	3.000
	14	1.320	SE05014	3.000
	16	1.510	SE05016	2.000
	18	1.700	SE05018	2.000
	20	1.880	SE05020	1.500
	22	2.070	SE05022	1.500
	24	2.260	SE05024	1.500
	26	2.450	SE05026	1.000
	28	2.640	SE05028	1.000
5	30	2.830	SE05030	1.000
	32	3.020	SE05032	1.000
	34	3.210	SE05034	800
	35	3.310	SE05035	800
	36	3.390	SE05036	800
	38	3.580	SE05038	800
	40	3.770	SE05040	800
	45	4.240	SE05045	600
	50	4.710	SE05050	600
	55	5.180	SE05055	500
	60	5.650	SE05060	500
	65	6.120	SE05065	500
	70	6.590	SE05070	500
	75	7.060	SE05075	500
	80	7.540	SE05080	500

# STEEL SPRING PINS SPINE ELASTICHE IN ACCIAIO ШТИФТЫ РАЗРЕЗНЫЕ ПРУЖИННЫЕ СТАЛЬНЫЕ

SPRING PINS  
SPINE ELASTICHE  
GOUPILLES ELASTIQUES  
SPANNSTIFTE  
ШТИФТЫ РАЗРЕЗНЫЕ

Ø	L	1.000 €/1000	SARIV box Kg.	Pcs x
	6	0.850	SE06006	5.000
	8	1.100	SE06008	4.000
	10	1.380	SE06010	3.000
	12	1.660	SE06012	2.000
	14	1.940	SE06014	2.000
	16	2.210	SE06016	1.500
	18	2.490	SE06018	1.200
	20	2.770	SE06020	1.200
	22	3.040	SE06022	1.200
	24	3.320	SE06024	1.000
	25	3.450	SE06025	1.000
	26	3.600	SE06026	1.000
	28	3.870	SE06028	1.000
	30	4.150	SE06030	800
6	32	4.430	SE06032	800
	34	4.840	SE06034	800
	36	5.260	SE06036	600
	40	5.540	SE06040	600
	45	6.230	SE06045	500
	50	6.920	SE06050	500
	55	7.610	SE06055	400
	60	8.300	SE06060	400
	65	8.990	SE06065	400
	70	9.690	SE06070	400
	75	10.400	SE06075	300
	80	11.100	SE06080	300
	85	11.800	SE06085	300
	90	12.500	SE06090	300
	95	13.100	SE06095	300
	100	13.800	SE060100	300

Ø	L	1.000 €/1000	SARIV box Kg.	Pcs x
	10	1.810	SE07010	2.000
	12	2.160	SE07012	2.000
	14	2.535	SE07014	1.500
	16	2.895	SE07016	1.500
	18	3.260	SE07018	1.000
	20	3.625	SE07020	1.000
	22	3.980	SE07022	1.000
	24	4.345	SE07024	1.000
	26	4.710	SE07026	800
	28	5.065	SE07028	800
	30	5.430	SE07030	600
	32	5.795	SE07032	600
7	36	6.550	SE07036	500
	40	6.800	SE07040	500
	45	7.590	SE07045	400
	50	9.060	SE07050	300
	55	9.955	SE07055	300
	60	10.850	SE07060	300
	65	11.745	SE07065	300
	70	12.695	SE07070	300
	75	13.600	SE07075	300
	80	14.550	SE07080	300
	85	15.400	SE07085	250
	90	16.300	SE07090	200
	95	17.200	SE07095	200
	100	18.100	SE070100	200

**SARIV**

# STEEL SPRING PINS

## SPINE ELASTICHE IN ACCIAIO

## ШТИФТЫ РАЗРЕЗНЫЕ

## ПРУЖИННЫЕ СТАЛЬНЫЕ

SPRING PINS  
 SPINE ELASTICHE  
 GOUPILLES ELASTIQUES  
 SPANNSTIFTE  
 ШТИФТЫ РАЗРЕЗНЫЕ

∅	L	1.000 €/1000	SARIV box Kg.	Pcs x
	10	2.240	SE08010	1.500
	12	2.660	SE08012	1.000
	14	3.130	SE08014	1.000
	16	3.580	SE08016	1.000
	18	4.030	SE08018	1.000
	20	4.480	SE08020	800
	22	4.920	SE08022	600
	24	5.370	SE08024	500
	26	5.820	SE08026	400
	28	6.260	SE08028	400
	30	6.710	SE08030	400
	32	7.160	SE08032	400
	34	7.650	SE08034	300
<b>8</b>	35	7.900	SE08035	300
	36	8.060	SE08036	300
	40	8.950	SE08040	300
	45	10.100	SE08045	300
	50	11.200	SE08050	300
	55	12.300	SE08055	300
	60	13.400	SE08060	300
	65	14.500	SE08065	250
	70	15.700	SE08070	250
	75	16.800	SE08075	250
	80	18.000	SE08080	250
	85	19.000	SE08085	200
	90	20.100	SE08090	200
	95	21.300	SE08095	200
	100	22.400	SE080100	200

∅	L	1.000 €/1000	SARIV box Kg.	Pcs x
	10	3.690	SE10010	1.000
	12	4.430	SE10012	1.000
	14	5.170	SE10014	800
	16	5.900	SE10016	500
	18	6.620	SE10018	500
	20	7.380	SE10020	500
	22	8.120	SE10022	400
	24	8.860	SE10024	400
	26	9.590	SE10026	300
	28	10.300	SE10028	300
	30	11.100	SE10030	300
	32	11.800	SE10032	250
	35	13.000	SE10035	250
<b>10</b>	36	13.300	SE10036	250
	40	14.800	SE10040	200
	45	16.600	SE10045	200
	50	18.400	SE10050	200
	55	20.300	SE10055	150
	60	22.100	SE10060	150
	65	24.000	SE10065	150
	70	25.800	SE10070	150
	75	27.700	SE10075	150
	80	29.500	SE10080	100
	85	31.400	SE10085	100
	90	33.200	SE10090	100
	95	35.000	SE10095	100
	100	36.900	SE100100	100
	30	16.700	SE12030	250
	40	22.200	SE12040	150
	50	27.800	SE12050	150
<b>12</b>	60	33.300	SE12060	100
	70	38.900	SE12070	100
	80	44.400	SE12080	100
	100	55.500	SE120100	100

**SOLID AND SEMI-TUBULAR RIVETS  
RIBATTINI FORATI E SEMIFORATI  
RIVETS PLEINS ET SEMI-FORÉS  
VOLLNIETE UND HALBHÖHLNIETE  
ЗАКЛЕПКИ ПОД МОЛОТОК И ПОЛУПУСТОТЕЛЫЕ ЗАКЛЕПКИ**



SCREWS  
 VITI  
 VIS  
 SCHRAUBEN  
 ВИНТЫ

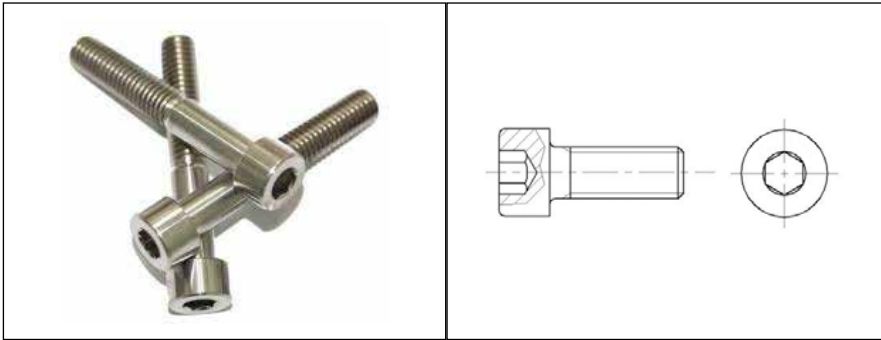

**DIN 912**

Hexagon socket cap head screws  
 Viti a testa cilindrica con cava esagonale  
 Винты с цилиндрической головкой и внутренним шестигранником под ключ

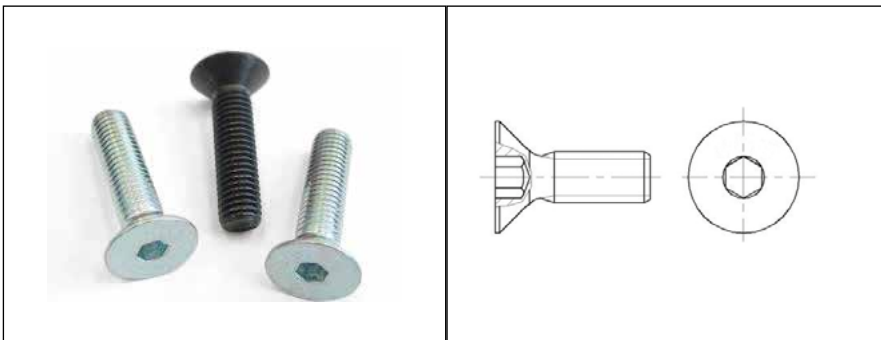

**DIN 7991**

Hexagon socket countersunk head screws  
 Viti a testa svasata piana con cava esagonale  
 Винты с потайной плоской головкой и внутренним шестигранником под ключ

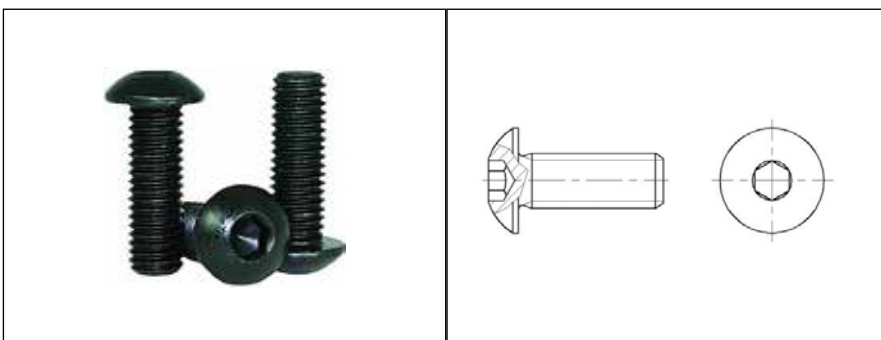

**ISO 7380**

Hexagon socket button head screws  
 Viti con testa a bottone con cava esagonale  
 Винты с полукруглой головкой и внутренним шестигранником под ключ

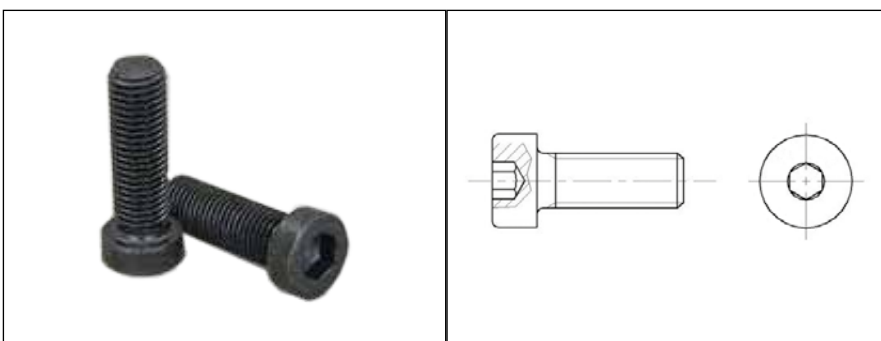

**DIN 7984**

Hexagon socket cheese head screws  
 Viti a testa cilindrica ribassata con cava esagonale  
 Винты с цилиндрической заниженной головкой и внутренним шестигранником под ключ